







































S I M E S

# FOCUS

INSTALLATION, USE AND MAINTENANCE AND WASTE MANAGEMENT INSTRUCTIONS  
ISTRUZIONI DI MONTAGGIO, USO, MANUTENZIONE E SMALTIMENTO  
NOTICE DE MONTAGE, UTILISATION, ENTRETIEN ET ÉCOULEMENT



Type Tipo Art Catégorie Tipo	Lamp Lampada Lampe Lampe Lámpara	IK	Weight Peso Gewicht Poids Peso	Max surface area exposed to the wind Superficie Max esposta al vento Max Fläche dem Wind ausgesetzt Max surface exposée au vent Superficie Max expuesto al viento
<b>MICROFOCUS</b>	LED  220-240V  QR-LP 111 50W 12V G53  230-240V  QPAR30 75W E27  230-240V  HIT-TC CE 20W PGJ5   230-240V 	09	1,6kg	0,02m <sup>2</sup>
<b>MINIFOCUS</b>	LED  220-240V  HIT-TC CRI 20W G8,5   230-240V  HIT-TC CRI 35W G8,5   230-240V  TC-TEL 18W Gx24q-2  230-240V 	09	4kg	0,042m <sup>2</sup>
<b>FOCUS</b>	LED   220-240V  LED COB  220-240V  HIT-CRI 70W G12   230-240V  HIT-CRI 150W G12   230V 	10	11kg	0,095m <sup>2</sup>
<b>MEGAFOCUS</b>	LED   220-240V  LED COB  220-240V  HIT-CRI 250W G12   230-240V 	10	19kg	0,138m <sup>2</sup>

## MICROFOCUS

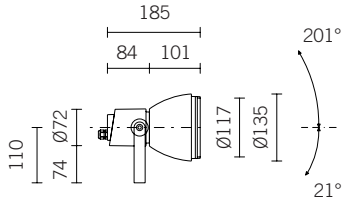

## S.1052 LED VERSIONS

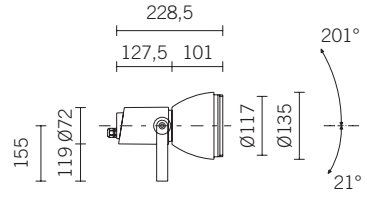

## MINIFOCUS

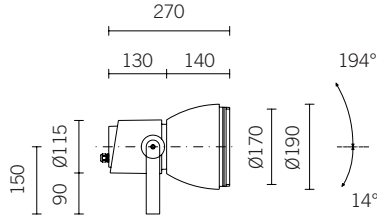

## FOCUS

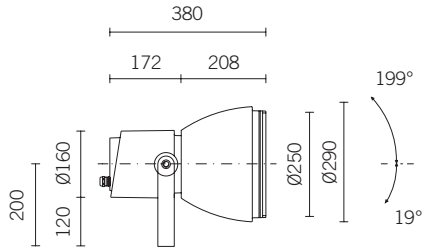



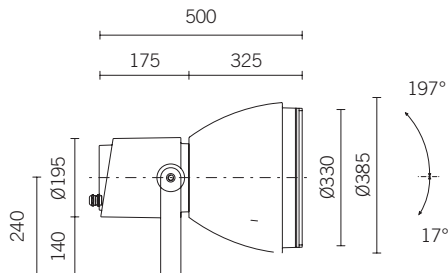

## MEGAFOCUS





# INSTALLATION RACCOMANDATIONS RACCOMANDAZIONI PER L'INSTALLAZIONE RECOMMENDATIONS POUR LE MONTAGE

# S I M E S

  	<p>GB Technical data on the internal label.          I Dati tecnici sulla etichetta interna.          D Technische Daten auf der internen Bezeichnung.          F Données techniques sur l'étiquette interne.          E Datos técnicos en la etiqueta interna.</p>
---	---

<p><b>LED</b></p> 	<p>GB Risk Group 1 (EN 62471:2008-09).          I Gruppo di Rischio 1 (EN 62471:2008-09).          D Gefährgruppe 1 (EN 62471:2008-09).          F Leroupe de risque 1 (EN 62471:2008-09).          E Grupo de riesgo 1 (EN 62471:2008-09).          SE Risk Group 1 (EN 62471:2008-09).          NL Risico groep 1 (EN 62471:2008-09).          RU Группа риска 1 (EN 62471:2008-09).          FI Riskiryhmän 1 (EN 62471:2008-09).          P Grupo de Risco 1 (EN 62471:2008-09).</p>
---	--

 	<p>GB The article is suitable for outside and inside use.          I Prodotto idoneo all'uso esterno ed interno.          D Artikel ist geeignet zur zußerlichen und inneren Anwendung.          F L'article est adapte pour usage externe et interne.          E Producto adecuado para uso en exteriores y en interiores.</p>
--	---

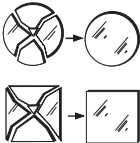

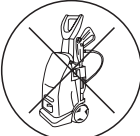
 <p>- Usare solo ricambi originali.          - Use only original spare parts.</p>	<p>GB In case of diffuser damage change it before to switch on the fitting.          I Sostituire lo schermo in caso di danneggiamento prima di riutilizzare l'apparecchio.          D Beschädigte Abdeckungen vor erneuter Inbetriebnahme austauschen.          F En cas de dommages, remplacer le diffuseur avant réutilisation de l'appareil.          E En caso de difusor dañado cambiarlo antes de encender el aparato.          SE Vid byte av trasigt glas, kopplas armaturen ur.          NL Bij glasbreuk dient het glas vervangen te worden vooraleer het armatuur aan te schakelen.          RU в случ а стoвpeждeнияpaccивaтeлявключaйтe вeтeльныицoдeтoзaмeнe          FI Vioittunut suojalasi on vaihdettava uuteen ennen valaisimen käyttöä.          P Em caso de avaria do difusor, substituir por outro antes da reutilização da luminária.</p>
--	--

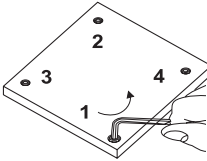
	<p>GB Do not use water high pressure cleaners.          I Non utilizzare idropulitrici.          D Hochdruckreiniger benutzung ist verboten.          F Ne utilisez pas de nettoyeur haute pression sur la luminaire.          E No utilice limpiadores a presión.</p>
--	--

	<p>GB Lock and unlock the screws following an alternate sequence.          I Bloccare e sbloccare le viti di chiusura con sequenza alternata.          D Die Verschlusschrauben kreuzweise anziehen bzw. lösen.          F Bloquer et débloquer les vis de fermeture "en croix", par séquence alternée.          E Abrir y cerrar los tornillos en secuencia alterna.          SE Dra åt eller lossa skruvarna genom att följa nummeranvisningarna.          NL Maak de schroeven steeds allemaal geleidelijk los of vast: schroef dus nooit 1 vjvs helemaal los of vast, maar schroef alle schroeven diagonaal beetje bij beetje los of vast          RU <b>Закручивайте и раскручивайте болты по очередности, в указанной последовательности.</b>          FI Kiristä ja avaa ruuvit kivan mukaisessa järjestyksessä.          P Apertar e desapertar os parafusos de fecho, "em cruz" em sequência alternada.</p>
--	--

# INSTALLATION RACCOMANDAZIONI RACCOMANDAZIONI PER L'INSTALLAZIONE RECOMMENDATIONS POUR LE MONTAGE

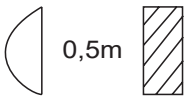
# S I M E S

	GB	Minimum distance from the surface to be lit.	 <b>ONLY FOR METAL HALIDE VERSION</b>
	I	Distanza minima dalla superficie da illuminare.	
	D	Minimaler Abstand von der Oberfläche beleuchtet werden.	
	F	Minimun distance de la surface de éclairer.	
	E	Distancia mínima desde la superficie a iluminar.	

	GB	Use lamps with a low level of UV radiation.
	I	Utilizzare lampade con basso livello di radiazione UV.
	D	Verwenden Sie Lampen mit einer niedrigen UV-Strahlung.
	F	Utilisez des lampes avec un faible niveau de rayonnement UV.
	E	Use lámparas de bajo nivel de radiación UV.

	GB	The LED module contained in this luminaire shall only be replaced by the manufacturer. For further informations, please contact your supplier.
	I	Il modulo LED contenuto in questo apparecchio di illuminazione può essere sostituito esclusivamente dal costruttore. Per un'eventuale sostituzione, si prega contattare il proprio rivenditore.
	D	Das LED-Modul in dieser Leuchte enthalten darf nur vom Hersteller ersetzt werden. Für weitere Informationen, wenden Sie sich bitte an Ihren Lieferanten.
	F	La source lumineuse contenue dans ce appareil peut être échangé seulement par le constructeur. Merci de contacter le service commercial pour toutes les informations.
	E	El módulo LED contenida en esta luminaria sólo se sustituye por el fabricante. Para más información, póngase en contacto con su proveedor.

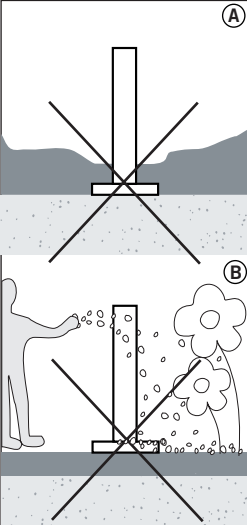
	GB	All parts of products in contact with soil (post bases, etc.) must not be covered by soil (A) or must not be in contact with aggressive chemical elements (ex. fertilisers, herbicides, lime) (B). Clean periodically the parts near ground in order to remove possible soil heap on bases or screw heads.
	I	Tutte le parti dei prodotti direttamente a contatto con il terreno non devono mai essere ricoperte dal terreno stesso (A) o venire a contatto con sostanze chimiche aggressive (es. fertilizzanti, diserbanti, calce) (B). Pulire periodicamente le parti ricoperte da accumuli di terriccio.
	D	Die teile des produkt, die mit boden nebenein ander stehen (wie sockel vom maste), müssen mit boden nie gedeckt sein werden (A) oder dürfen nicht mit dem erdreich oder aggressiven chemischen stoffen (z.b. dünger,unkrautvernichter, kalk) in berührung kommen) (B). Putzen sie periodisch diese teile vom bodenmasse.
	F	Toutes les parties des produits qui sont directement en contact avec le terrain (A), (les bases des poteaux), ne doivent jamais être recouvert par le terrain ou venir au contact de substances chimiques agressives (ex : fertilisants, herbicides, chaux) (B). Nettoyer périodiquement les parties recouvertes des terreau.
	S	Todas las partes del producto directamente en contacto con el suelo nunca deben ser cubiertas con el mismo suelo (A) o entran en contacto con productos químicos agresivos (por ejemplo, fertilizantes, herbicidas, cal) (B). Limpie periódicamente las partes cubiertas por acumulaciones de tierra.



- GB Electronic equipment sensitive to voltage surges. The installation of a protection device against overvoltages on the electrical system attenuates the intensity of these phenomena protecting apparatus from the risk of damage.
- I Apparecchiatura elettronica sensibile alle sovratensioni. L'installazione di un dispositivo di protezione dalle sovratensioni sull'impianto elettrico, attenua l'intensità di questi fenomeni proteggendo gli apparecchi dal rischio che vengano danneggiati.
- D Elektronische Geräte empfindlich auf Überspannungen. Der Einbau einer Schutz Einrichtung gegen Überspannungen in elektrischen System dämpft die Intensität dieser Phänomene Vorrichtung zum Schutz vor der Gefahr einer Beschädigung.
- F Équipements électroniques sensibles aux surtensions. L'installation d'un dispositif de protection contre les surtensions sur le câblage atténue l'intensité de ces phénomènes Dispositif de protection contre le risque d'être endommagé.
- E Los equipos electrónicos sensibles a las sobretensiones. La instalación de un dispositivo de protección contra sobretensiones en el sistema eléctrico, reduce la intensidad de estos fenómenos que protegen el aparato de la riesgo de ser dañado.



- GB Caution, risk of electric shock.
- I Attenzione, rischio di scossa elettrica.
- D Achtung, Gefahr eines Stromschlags.
- F Attention, risque de choc électrique.
- E Precaución, riesgo de descarga eléctrica



- GB Retain the instructions.
- I Conservare le istruzioni.
- D Bewahren Sie die Anleitung.
- F Conservez ces instructions.
- E Conserve las instrucciones.

- GB ANY MODIFICATION TO THIS FITTING IS FORBIDDEN WITHOUT AUTHORIZATION !!**  
The safety of the fitting is guaranteed only respecting the electrical European norms and the mounting instructions in this box; therefore it is important to conserve them. The respect of these instructions is very important for the fitting and the main line life.  
Installation should be carried out by a suitable qualified person in accordance with good electrical practice and the appropriate national wiring regulations.  
Do not use lamps with higher power than indicated.  
Disconnect main voltage before maintenance operations.
- I OGNI MODIFICA DELL'APPARECCHIO E' PROIBITA SENZA PREVIA AUTORIZZAZIONE !!**  
La sicurezza dell'apparecchio è garantita solo rispettando le normative europee del settore elettrico e le istruzioni contenute in questa scatola; pertanto è necessario conservarle. Il rispetto di queste istruzioni è fondamentale per il corretto funzionamento dell'apparecchio e dell'impianto.  
L'installazione deve essere fatta da personale qualificato.  
Non utilizzare lampade di potenza superiore al limite indicato.  
Togliere tensione prima di eseguire le operazioni di manutenzione.
- D JEDE UNBEFUGTE ÄNDERUNG AN DIESER LEUCHE IST VERBOTEN !!**  
Die Sicherheit der Leuchte ist nur bei Einhaltung der europäischen Normen und der in dieser Packung enthaltenen Montageanleitungen gewährleistet. Diese sind daher sorgfältig aufzubewahren.  
Diese Anweisungen sind daher unbedingt einzuhalten, um die Funktionsfähigkeit dieser Leuchte und der Beleuchtungsanlage sicherzustellen. Bitte sorgfältig aufbewahren.  
Keine Lampen höherer Leistung als angegeben verwenden.  
Diese Leuchte muss fachmännisch installiert werden.  
Vor Wartungsarbeiten die Leuchte vom Netz trennen.
- F TOUTE MODIFICATION DE CET APPAREIL, SANS AUTORISATION, EST INTERDITE !!**  
La sécurité des appareils est garantie uniquement en respectant les normes électriques européennes et les instructions contenues dans l'emballage; aussi est-il nécessaire de les conserver. Le respect de ces instructions est fondamental pour un fonctionnement correct de l'appareil et de l'implantation électrique et doit être suivi scrupuleusement.  
Ne pas utiliser des puissances de lampes supérieures à la limite indiquée.  
L'installation doit être effectuée par des personnes qualifiées.  
Couper l'alimentation avant d'exécuter toute manutention.
- E CUALQUIER MODIFICACION DE LOS APARATOS ESTA PROHIBIDA SIN AUTORIZACION !!**  
La seguridad de los aparatos está garantizada solamente respetando las normas eléctricas Europeas y las instrucciones de montaje incluidas en la caja, por lo tanto es importante conservarlas. El respeto de estas instrucciones es fundamental para el correcto funcionamiento del aparato y de la instalación.  
La instalación debe hacerla personal calificado.  
No usar lámparas de potencia superior a la indicada.  
Desconectar la alimentación principal antes de continuar las operaciones de mantenimiento.
- SE ALL OMBYGGNAD AV DENNA ARMATUR ÄR FÖRBUDEN !!**  
Säkerheten av och garantin för armaturen gäller endast om man följer det Europeiska elektriska normerna samt följer den till armaturen bifogade monteringsanvisningen; därför är det viktigt att spara den.  
Installation får endast utföras av behörig person i enlighet med god elektrisk installations- och nationella installationsregler.  
Använd ej högre effekt än angivet.  
Koppla från armaturen före allt underhåll.
- NL ALLE NIET VOORAF TOEGESTANE WIJZIGINGEN AAN DIT TOESTEL ZIJN VERBODEN !!**  
Uitsluitend op basis van de geldende Europeese normen, en de montagehandleiding in deze doos kunnen wij de veiligheid van de armatuur garanderen. Het is daarvoor van belang deze goed te bewaren. Het respecteren van deze instructies is van belang voor de levensduur van de installatie.  
De installatie moet worden uitgevoerd door een goed gekwalificeerd persoon met de juiste opleiding, en op basis van de nationale regelgeving m.b.t. bedraden.  
Gebruik geen lampen met hogere wattages dan aangegeven.  
Sluit de voedingsspanning af voor onderhoud.
- RU ЛЮБЫЕ ИЗМЕНЕНИЯ КОНСТРУКЦИИ СВЕТИЛЬНИКА БЕЗ СОГЛАСОВАНИЯ ЗАПРЕЩАЮТСЯ !!**  
Безопасность светильника гарантирована только при соблюдении электрических норм и правил (ПУЭ), а также инструкции по установке светильника, которая находится в коробке. Поэтому очень важно сохранить их.  
Установка должна осуществляться квалифицированным электриком, имеющим опыт установки подобного оборудования, а также имеющим соответствующий допуск к работам.  
Do not use lamps with higher power than indicated.  
Не используйте источники света мощностью выше обозначенной.
- FI KAIKENLAISET VALAISIMEN MUUTOSTYÖT ILMAN VALMISTAJAN SUOSTUMUSTA OVAT KIELLETTYJÄ !!**  
Valaisimen käyttöturvallisuutta ei taata, mikäli valaisinta ei ole asennettu pakkauksessa tulleiden ohjeiden mukaisesti ja käytetty Eurooppalaisten normien mukaisesti; näin ollen on tärkeää säilyttää nämä ohjeet. Valaisimen ja syöttökaapelin käyttöikää ajatellen näiden ohjeiden noudattaminen on ensiarvoisen tärkeää.  
Asennustyö on suoritettava valtuutetun sähköasentajan toimesta.  
Käytä vain arvokilvessä mainittua lamputyyppiä. Valaisimelle tarkoitettua lampputehoa ei saa ylittää.  
Katkaise pääjännite huoltotöiden ajaksi.

**P QUALQUER ALTERAÇÃO NESTE APARELHO, SEM AUTORIZAÇÃO, É INTERDITA !!**

A segurança das luminárias é garantida somente se as normas eléctricas Europeias forem respeitadas bem como as instruções de montagem que estão na embalagem. É necessário conservá-las após montagem. A observação das instruções é fundamental para um funcionamento correcto da mesma e a ligação eléctrica deve ser seguida escrupulosamente.

A instalação deve ser executada só por pessoal qualificado.  
Não utilizar lâmpadas com potência superior ao limite indicado.  
Cortar a alimentação antes de executar a manutenção.

**GB GENERAL MAINTENANCE RECOMMENDATIONS**

A scheduled maintenance programme must be carried out on the installation and the fittings regardless of their IP rating or application – these must include the following operations:

- clean the fittings from dirt that may be deposited on the protection grills and in the heads of the screws by following the installation instructions attached to each fitting.
- Check that the screws are not loose on the various components of the luminaire (glass frame, cable entry , ...).
- Check each cable gland, and cable for damage and that the cable gland has not come loose.
- For each Isolation Class 1 fitting check that the earth cable has not come loose. The clip must not show signs of oxidation, damage or become loose.
- For class 2 fittings check any eventual plastic / isolating covering in order to verify any damage.
- Check that all the seals are in good condition and that they are not dry, damaged or split.
- Check the glass or plastic screen for damage and replace if required.
- Check for water inside the luminaire's housing and its recessing box.

The internal components such as the ballasts, transformers, washers and screws must not show clear signs of oxidation or rust. Clear traces of rust and oxidation will indicate the presence of water inside the luminaire.

In case of damage the components must be replaced by original components and spare parts before using the fitting.

We also recommend to check the fitting each time the lamp is replaced or at least once a year or within the prescribed maintenance schedule period depending on the type of installation.

**I RACCOMANDEAZIONI GENERALI PER LA MANUTENZIONE**

Per tutti gli apparecchi di illuminazione al di là della classe di appartenenza e del tipo di utilizzo deve essere effettuata a cadenza programmata la manutenzione dell'installazione che deve prevedere almeno le seguenti operazioni:

- Pulire periodicamente gli apparecchi per rimuovere gli accumuli di sporco che si possono depositare sulle griglie e nella testa delle viti seguendo le ulteriori indicazioni riportate sulle istruzioni di montaggio allegate con ogni apparecchio.
- Verificare il serraggio delle viti che fissano le varie parti dell'apparecchio (cornice vetro, vano di ingresso cavo, ecc.).
- Verificare l'integrità di tutti i pressacavi e dei cavi. Verificare il serraggio dei pressacavi.
- Per gli apparecchi in classe I verificare il serraggio del filo di terra all'apparecchio; il morsetto non deve presentare allentamento né ossidazione o danni di qualsiasi tipo. Se il caso serrare a fondo la vite del morsetto.
- Per gli apparecchi in classe II verificare eventuali involucri plastici/isolanti, allo scopo di individuare eventuali danni agli isolamenti.
- Verificare l'integrità e l'elasticità delle guarnizioni, che non devono risultare: Secche, Pizzicate, Interrotte o Danneggiate.
- Verificare l'integrità dello schermo in vetro o plastico. Sostituirlo in caso di rottura o danneggiamento.
- Verificare l'eventuale accumulo di acqua all'interno dell'apparecchio o della cassaforma.

I componenti interni come l'alimentatore, il trasformatore, la morsetteria, ecc. non devono presentare segni consistenti di ruggine o di ossidazione. La presenza di tali segnali indica una possibile penetrazione di acqua all'interno dell'apparecchio.

In caso di componenti danneggiati essi vanno sostituiti prima di rimettere in servizio l'apparecchio utilizzando solo ricambi originali.

Si consiglia di effettuare controlli ad ogni sostituzione di lampada o almeno ogni anno scegliendo il periodo più breve in relazione al tipo di impianto.

**D GENERELLE WARTUNGSEMPFEHLUNGEN**

Ein geplantes Wartungsprogramm sollte für die Installation einer jeden Beleuchtungsanlage, unabhängig von der IP Schutzart oder Anwendung ausgearbeitet werden.

Dabei sind die folgenden Punkte unbedingt durchzuführen:

- Reinigen Sie die Leuchten von Schmutz, der sich in allen Bereichen abgesetzt haben könnte. Berücksichtigen Sie dabei auch die Schraubenköpfe sowie die Komponenten des Zubehörs, wie z. B. Schutzgitter gemäß den Angaben der im Lieferumfang beigefügten Montageanleitung
- Stellen Sie sicher, dass sich Befestigungsschrauben an der Leuchte selbst oder an Zubehörfteilen nicht gelöst oder gelockert haben (z. B. auch an Abdeckgläsern oder Kabeleinführungen).
- Überprüfen Sie die Kabeleinführung auf festen Sitz und sämtliche Zuleitungen auf mögliche Verletzungen des Schutzmantels
- Bei Leuchten der elektrischen Schutzklasse I ist sicherzustellen, dass die Erdungsleitung fest sitzt. Die Erdungslaschen selbst dürfen keine Spuren von Korrosion aufweisen.
- Bei Leuchten der elektrischen Schutzklasse II sind alle Plastikteile der doppelten Isolierung auf Brüche oder mögliche Verletzungen zu überprüfen
- Prüfen Sie sämtliche Formdichtungen auf Funktion und äußere Erscheinung bezüglich Versprödung, Austrocknung oder Zersplitterung
- Prüfen Sie die Abdeckungen auf Risse oder Bruch und Ersetzen sie diese im Schadensfall.
- Prüfen Sie die Leuchten- und Eingießgehäuse auf Wassereinfall

Sämtliche sich in der Leuchte befindenden Komponenten wie Vorschalt- oder Netzgeräte, Unterleg- oder Zahnscheiben dürfen keine Anzeichen von Rost oder Oxidation aufzeigen. Diese Anzeichen signalisieren eindeutig, dass sich Feuchtigkeit innerhalb der Leuchte befindet.

Sollten Komponenten innerhalb der Leuchte defekt oder gebrochen sein, so müssen sie durch Original Ersatzteile fachgerecht ersetzt werden, bevor die Leuchte in Betrieb gehen kann.

Wir empfehlen weiterhin, die Leuchte je nach Anwendungsfall und Installationsart auf den termingerechten Leuchtmittelwechsel bei der Wartungsarbeit zu überprüfen und die vorgegebenen Intervalle der Leuchtmittel Lieferanten einzuhalten.



**F RECOMMANDATIONS GENERALES POUR L'ENTRETIEN**

Pour tous les appareils d'éclairage à part la classe à laquelle ils appartiennent et le type d'utilisation, un entretien à échéance programmée doit être effectuée; il doit prévoir au moins les opérations suivantes :

- nettoyer périodiquement les appareils et enlever les accumulations de saleté qui peuvent se déposer sur les grilles et les vis en suivant les indications supplémentaires dans les notices d'instructions qui accompagnent chaque appareil
- Vérifier le serrage des vis qui fixent les différentes parties de l'appareil ( enjoliveur de la verrière, entrée câble etc.)
- Vérifier le parfait état de tous les presse-étoupes et des câbles. Vérifier le serrage des presse-étoupes .
- Pour les appareils de Classe I vérifier le serrage du fil de mise-à-la-terre de l'appareil : le domino ne peut présenter de détachement ou de mauvaises conditions de quelque nature qu'il soit. Au besoin, serrer à fond la vis de fixation du domino.
- Pour les appareils de Classe II vérifier les enveloppes éventuelles en plastique ou isolants afin d'identifier des dégâts aux isolations
- Vérifier le parfait état et l'élasticité des joints qui ne peuvent pas se présenter comme secs, pincés, interrompus ou endommagés
- Vérifier le parfait état de l'écran / du diffuseur en verre ou matière thermoplastique. Le remplacer en cas de casse ou d'endommagement
- Vérifier d'éventuels accumulations d'eau à l'intérieur de l'appareil ou du boîtier d'encastrement

Les composants internes tels que l'alimentateur, le transformateur, le domino etc. ne peuvent présenter des signes importants de rouille ou d'oxydation.

La présence de tels phénomènes signale une possible entrée d'eau à l'intérieur de l'appareil

En cas où des composants étaient endommagés, ceux-ci doivent être remplacés avec des pièces de rechange d'origine avant de remettre l'appareil en service.

Il est recommandé d'effectuer des contrôles lors de lu remplacement de la lampe ou au moins une fois par an en choisissant la période la plus courte en relation avec le type d'installation.

**E RECOMENDACIONES GENERALES PARA EL MANTENIMIENTO**

Para todas las luminarias en función del grado de protección así como de su uso, se debe efectuar un mantenimiento de las mismas

que tiene que incluir las siguientes operaciones:

-limpiar periódicamente las luminarias para quitar la suciedad que puede depositarse en la rejilla y en la cabeza de los tornillos siguiendo

Las instrucciones de instalación que acompañan a cada luminaria

-verificar que los tornillos están debidamente apretados a las distintas partes de la luminaria ( aro, entrada de cable...)

-verificar la integridad de todos los prensa cables y cables. Verificar que estén apretados los prensas.

-para las luminarias de clase I verificar la fijación del cable T.T, la regleta no debe presentar oxidación ni daños de cualquier tipo.

-para las luminarias de clase II verificar que no haya ninguna envoltura de plástico que pueda dañar la luminaria.

-verificar la elasticidad de la silicona, no tiene que estar ni seca, ni dañada ni rota.

-verificar la integridad de la cristal o del plástico. Sustituirlo en caso de rotura o daño.

-verificar de tanto en tanto la acumulación de agua en el interior de la luminaria o de la caja de empotrar.

Los componentes internos como el alimentador, transformador, regleta.. no deben estar oxidados. La presencia de cortes

Indica una posible entrada de agua en el interior de la luminaria

En caso de componentes dañados deben sustituirse por recambios originales antes de volver a utilizarlos.

Se aconseja efectuar controles de cada luminaria al menos una vez al año o dentro del periodo recomendado por el mantenimiento de cada luminaria en función de la instalación.

**SE ALLMÄNNA UNDERHÅLLSREKOMMENDATIONER**

Schemalagt underhåll måste utföras på installationen och anslutningarna oavsett kapslingsklassning eller applikation. I underhållet måste följande åtgärder ingå:

- Rengör anslutningarna från smuts som kan ha ansamlats på skyddsgallren och på skruvhuvudena genom att följa installation-särvisningarna som sitter på varje anslutning.

- Kontrollera att skruvarna inte sitter löst på de olika komponenterna i armaturen (glasram, kabelinföring, ...).

- Kontrollera varje kabelförskruvning, att kabeln inte är skadad och att förskruvningen inte sitter löst.

- Kontrollera på varje isoleringsklass 1-anslutning att jordkabeln inte sitter löst. Klämman får inte sitta löst eller visa tecken på oxidering eller skada.

- Kontrollera på klass 2-anslutningar alla eventuella plast- och isoleringshöljen för skador.

- Kontrollera att alla tätningar är i bra skick och inte är torra, skadade eller spruckna.

- Kontrollera glas- eller plastskärmen för skador och byt ut den vid behov.

- Kontrollera att det inte finns vatten innanför armaturens hölje och infällningsbox.

De interna komponenterna, såsom ballaster, transformatorer, brickor och skruvar, får inte visa tydliga tecken på oxidering eller rost. Tydliga tecken på rost och oxidering tyder på förekomst av vatten inuti armaturen.

Vid skada måste komponenterna ersättas med originalkomponenter och reservdelar innan anslutningen används.

Vi rekommenderar även att kontrollera anslutningen varje gång lampan ersätts eller åtminstone en gång om året eller inom tidsintervallet på det föreskrivna underhållsschemat beroende på typ av installation.

**NL ALGEMENE ONDERHOUDSINSTRUCTIES**

De installatie en de armaturen moeten, ongeacht hun IP-waarde of toepassing, onderhouden worden volgens een regelmatig onderhoudsprogramma. Hierbij moeten onderstaande handelingen uitgevoerd worden:

- verwijder vuil van de beschermroosters en in de koppen van de schroeven van de armaturen; volg hiervoor de instructies voor installatie voorzien bij elk armatuur;

- controleer of de schroeven, voorzien op de verschillende onderdelen van het armatuur (glasframe, kabelinvoer, enz.) goed vastzitten;

- controleer elke kabelwartel en kabel op schade; controleer of de kabelwartel niet losgekomen is;

- controleer voor elk armatuur van veiligheidsklasse 1 of de aardingskabel niet losgekomen is. De klem mag geen tekenen van roest/oxidatie en/of schade vertonen en mag niet losgekomen zijn;

- controleer de plastic of isolerende afdekking van de armaturen van veiligheidsklasse 2, op schade;
  - controleer of alle dichtingen in goede staat zijn, en niet droog, beschadigd of gebarsten;
  - controleer de glazen of plastic afdekking op schade en vervang indien nodig;
  - controleer of er geen waterinsipeling is in de behuizing van de armatuur en de inbouwdoos.
- De interne onderdelen zoals de ballasten, transformers, sluitringen en schroeven mogen geen duidelijke tekenen van oxidatie of roest vertonen. Roest- en oxidatiesporen duiden op de aanwezigheid van water in het armatuur.
- Indien de onderdelen beschadigd zijn, moeten ze vervangen worden door originele onderdelen en reservestukken vooraleer het armatuur wordt gebruikt.
- We raden ook aan om de armaturen telkens te controleren wanneer de lamp vervangen wordt, of minstens 1 x per jaar, of binnen de voorgeschreven onderhoudsperiode, afhankelijk van het type installatie.

#### **RU РЕКОМЕНДАЦИИ ПО ЭКСПЛУАТАЦИИ**

- Данные рекомендации по техническому обслуживанию должны соблюдаться при установке любых светильников, независимо от их сферы применения или степени защиты. Необходимо выполнить следующие операции:
- Очистите светильник, удалив загрязнения с защитной решетки и головок винтов, следуя инструкции по установке, прилагаемой к каждому светильнику.
  - Проверьте затяжку винтов, соединяющих части светильника (стеклянную рамку, место ввода кабеля и пр.)
  - Проверьте целостность и герметичность кабельных вводов.
  - Для светильников с классом защиты 1: проверьте подвод заземляющего кабеля к корпусу на отсутствие признаков окисления или механических повреждений.
  - Для светильников с классом защиты 2: убедитесь в целостности изоляционного покрытия.
  - Убедитесь, что все уплотнительные элементы в исправном состоянии.
  - Проверьте защитное стекло на предмет повреждений и при необходимости замените.
  - Убедитесь в отсутствии воды внутри корпуса светильника и коробки для встраивания.
  - Убедитесь, что внутренние компоненты, такие как драйвер, трансформатор, защитный блок и пр., не имеют следов окисления и ржавчины. Наличие таких признаков может быть результатом проникновения воды внутрь светильника.
  - В случае повреждения компоненты следует заменить до включения прибора, используя только оригинальные запасные части.
  - Мы рекомендуем проверять светильник по вышеописанному алгоритму при каждой замене источника света, как минимум раз в год или согласно расписанию проверки светильника, которое зависит от типа установки.

#### **FI YLEISET HUOLTOSUOSITUKSET**

- Järjestelmälle ja sen komponenteille on laadittava huoltosuunnitelma järjestelmän IP-luokituksesta tai käyttöolosuhteista riippumatta. Suunnitelmaan tulee kattaa seuraavat toimenpiteet:
- Puhdista komponenttien suojaritilöihin ja ruuvinkantoihin ym. kertynyt lika kunkin tuotteen asennusohjeiden mukaisesti.
  - Tarkasta ruuvien kireys valaisinten kaikista osista (lasikehykset, läpiviennit jne.).
  - Tarkasta kaikkien läpivienniteiden eheys ja tiukkuus sekä kaapeleiden vauriottomuus.
  - Eristyslukaan 1 valaisimet: tarkasta maadoituskaapelin liitännän tiukkuus. Liittimessä ei saa näkyä hapettumista eikä vaurioita, eikä liitäntä saa olla löysä.
  - Luokan 2 valaisimet: tarkasta kaikkien valaisimissa mahdollisesti olevien muovieristysosien kunto ja eheys.
  - Tarkasta, että kaikki tiivisteet ovat hyväkuntoiset, joustavat, eheät ja vauriottomat.
  - Tarkasta lasi- tai muovilevyt vaurioiden varalta ja vaihda tarvittaessa.
  - Tarkasta, ettei valaisinkoteloiden tai asennuskehiköiden sisään ole päässyt kosteutta.
- Valaisinten sisältämissä osissa, kuten liitäntälaitteissa, muuntajissa, aluslevyissä ja ruuveissa ei saa näkyä selviä merkkejä hapettumisesta tai ruosteesta. Selvät hapettumis- ja ruostemerkit tarkoittavat, että valaisimen sisälle on päässyt kosteutta. Vaurioituneet komponentit on korvattava alkuperäisillä komponenteilla ja varaosilla, ennen kuin valaisinten käyttöä jatketaan. Suosittelemme tarkastamaan valaisimet myös jokaisen lampunvaihdon yhteydessä tai vähintään yhden vuoden tai järjestelmän tyyppiin mukaan määräytyvän muun määräajan välein.

#### **P MANUTENÇÃO GERAL RECOMENDAÇÕES**





- Um programa de manutenção deve ser realizada na instalação e nas luminárias, independentemente da sua classificação de IP ou aplicação. O programa deve incluir as seguintes operações:
- Limpar o material proveniente da aplicação, terras que se podem depositar no anel da luminária e no vedante podendo afectar o IP da Luminária, ter também em consideração a zona de aperto dos parafusos, seguindo as instruções de instalação fornecidas com a luminária.
  - Verifique se não existem parafusos soltos sobre os vários componentes da luminária (moldura de vidro, entrada do cabo, ....).
  - Verifique da existência de danos no cabo ou na sua camada isolante dos consutores.
- Certifique-se que o mesmo está devidamente fixo na zona de Bucin ou no passa fios, garantindo o IP da luminária.
- Para poder assegurar o isolamento classe I deve-se certificar que o fio de terra fica devidamente fixo no local específico da luminária. A fixação não deve apresentar sinais de oxidação, danos ou se soltar.
  - Para a assegurar a classe II deve-se verificar se por debaixo das partes isolantes as ligações de demais partes eléctricas se encontram nas devidas condições.
  - Verifique se todos os vedantes estão em bom estado não apresentando sinais de estarem ressequidos ou danificados. Caso suceda devem ser colocados novos isolantes
  - Verifique o Difusor (Vidro; Policarbonato; metacrilato) se não apresenta nenhum dano, substituir se necessário..
  - Verifique se existe água no interior da luminária e sua caixa de embutir.
- Os componentes internos, como os reatores, transformadores, anilhas e parafusos não deve mostrar sinais claros de oxidação ou ferrugem.
- Vestígios claros de ferrugem e oxidação irá indicar a presença de água no interior da luminária.
- Em caso de danos os componentes devem ser substituídos por componentes originais e peças de reposição antes de dar uso à luminária.
- Recomendamos também que se verifique a instalação cada vez que a lâmpada seja substituída ou, pelo menos, uma vez por ano ou dentro do período de programação de manutenção prescrita, dependendo do tipo de instalação.

# INSTALLATION RACCOMANDAZIONI RACCOMANDAZIONI PER L'INSTALLAZIONE RECOMMENDATIONS POUR LE MONTAGE

# S I M E S

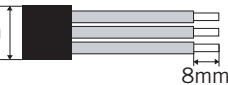
GB	If SIMES S.p.A. agrees to receive back some fittings for laboratory testing, they MUST NOT BE DISASSEMBLED. If necessary remove only the upper ring, to remove the fitting from its recessing box. The connection box, where the wiring to the terminal block is done, must not be opened and you must cut the cable around 10-20 cm from the connection box.
I	Nel caso in cui SIMES S.p.A. dia il consenso al reso di apparecchi per il controllo, essi dovranno essere resi senza essere smontati (aprire solo l'anello superiore per la rimozione dalla cassaforma, ove necessario). La scatola di cablaggio NON DEVE essere aperta; il pressacavo non deve essere toccato; deve essere lasciato un pezzo di cavo di alimentazione di 10-20 cm. uscente dalla scatola di cablaggio.
D	Wenn SIMES S.p.A. der Rücksendung von Leuchten zwecks Prüfung zustimmt, diese bitte vorher nicht zerlegen. Wenn nötig, nur den oberen Ring entfernen, um die Leuchte aus dem Einbauehäuse zu nehmen. Nicht den Anschlusskasten und die Verschraubung öffnen, das Kabel in 10-20 cm Abstand von der Anschlussdose durchtrennen.
F	Dans le cas où SIMES S.p.a donne son accord pour un retour d'appareils afin d'en effectuer le contrôle, ceux-ci devront être rendus sans être démontés (ouvrir uniquement la collerette supérieure pour le désolidariser du boîtier d'encastrement, si nécessaire). La boîte de câblage ne DOIT PAS être ouverte, le presse-étoupe ne doit pas être touché ; il faut laisser, à la sortie de la boîte de câblage, un morceau de câble d'alimentation de 10 à 20 cm.
E	En el caso que SIMES S.p.A. deba analizar algún aparato , deberá entregarse sólo el aro superior. La caja de cableado NO DEBE ABRIRSE; el prensa no debe tocarse y debe dejarse un cable de 10-20cm saliendo de la caja de cableado.

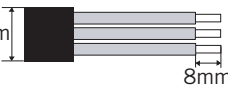
GB	Use only flexible cables of suitable diameter according to the national installation standards. DO NOT USE HARD CABLES OR ARMoured CABLES. Use only supply cables with double case. Do not enter with single cables.
I	Utilizzare esclusivamente cavi flessibili di diametro adatto in conformità alle norme di installazione nazionali. NON USARE CAVI RIGIDI e/o CON ANIMA METALLICA. Utilizzare esclusivamente cavi di alimentazione in doppia guaina. Non entrare con fili singoli. Nur flexible Kabel verwenden gemäß den landesspezifischen Installations-standards.. KEINE STARREN LEITUNGEN VERWENDEN. Brauchen Sie nur die Speisekabel mit doppeltem Mantel. Nicht mit einzelnen Kabeln geben.
D	Utiliser uniquement des câbles souples selon les normes nationales d'installation. NE PAS UTILISER DE CABLES RIGIDES ou ARMES. Ne pas entrer avec les fils séparés.
F	Utilizar solo cables flexibles con diámetro adecuado de acuerdo con las normas de instalación nacional. NO ENTRAR CON CABLES RIGIDOS o BLINDADOS. Utilice sólo los cables de alimentación con doble funda. No vayas con cables individuales.
E	Använd endast kablar med avsedd diameter enligt den nationella installation standard. ANVÄND EJ HÅRDA ELLER ARMERADE KABLAR. Använd endast nåtssladdar med dubbel mantel. Gå inte med enstaka trådar.
SE	Gebruik enkel soepele kabels volgens de nationale installatie-norm. GEEN VASTE OF GEWAPENDE SNOEREN GEBRUIKEN ! Gebruik uitsluitend netsnoeren met dubbel omhulsel. Ga niet met enkele draden.
NL	Используйте только гибкие кабели в соответствии с принятыми нормами. Ни в коем случае не используйте жесткие или армированные кабели. Используйте только шнуры питания с двойной оболочкой. Не ходи с отдельных проводов.
RU	Käytä vain liitoskaapelia joustava kansallisen asennusstandardi. ÄLÄ KÄYTÄ JÄYKKÄÄ TAI ARMEERATTUA KAAPELIA ! Käytä vain virtajohdot kaksinkertainen tuppi. Älä mene lankaa.
FI	Utilizar sempre cabos flexíveis de diâmetro adequado de acordo com as normas nacionais de instalação. NUNCA UTILIZAR CABOS RÍGIDOS OU ARMADOS. Utilize apenas os cabos de alimentação com bainha dupla. Não vá com fios individuais
P	

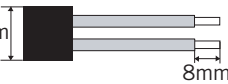
MICROFOCUS MINIFOCUS		min 3x1mm <sup>2</sup> max 3x2,5mm <sup>2</sup>	Ø 6÷12mm 
FOCUS MEGAFOCUS CLASS I		min 3x1mm <sup>2</sup> max 3x4mm <sup>2</sup>	Ø 10÷14mm 
FOCUS MEGAFOCUS CLASS II		min 2x1mm <sup>2</sup> max 2x4mm <sup>2</sup>	Ø 10÷14mm 

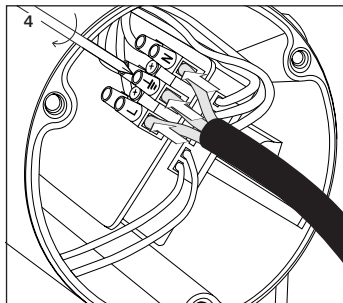
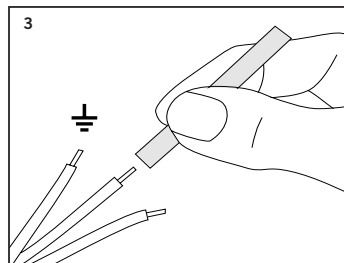
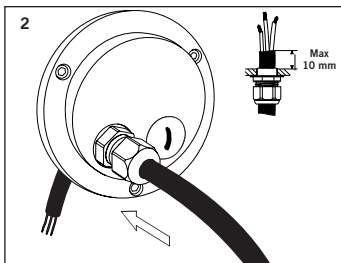
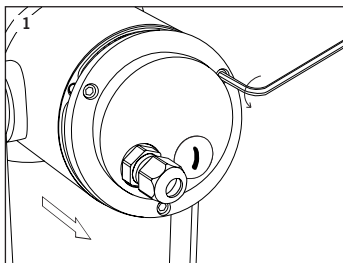

**CLASS I**

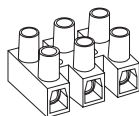

**(L) → L** Life / Linea / Leitung  
 Ligne / Linea / Fas  
 Fase / Фаза / Vaihe  
 Linha  
 Brown / Marrone / Braun  
 Brun / Marrón / Brun  
 Bruin / коричневый / Ruskea  
 Marrom

**(N) → N** Neutral / Neutro / Null  
 Neutre / Neutro / Nolla  
 Nul / Ноль / Nolla  
 Neutro  
 Blue / Blu / Blau  
 Bleu / Azul / Blå  
 Blauw / синий / Sininen  
 Azul

**(⊕) → ⊕** Earth / Terra / Erde  
 Terre / Tierra / Jord  
 Aarde / Земля / Suojamaa  
 Terra  
 Yellow-Green / Giallo-Verde / Gelb-Grün  
 Jaune-Vert / Amarillo-Verde / Gul-Grön  
 Geel-Groen / Желто-зеленый  
 Keltainen-Vihreä / Amarelo-Verde

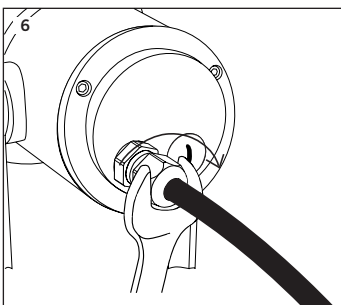
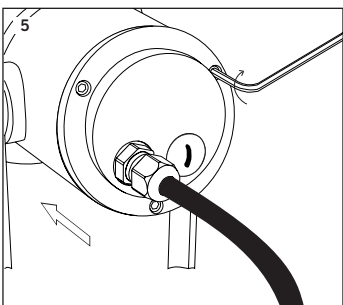

**INSTALLATION AND WIRING CL II VERSION  
 INSTALLAZIONE E CABLAGGIO VERSIONE CL II  
 INSTALLATION ET CÂBLAGE VERSION CL II**

**S I M E S**

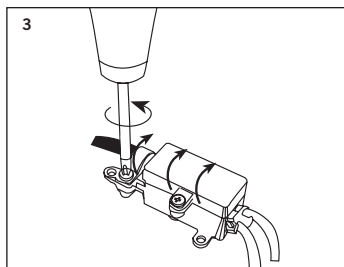
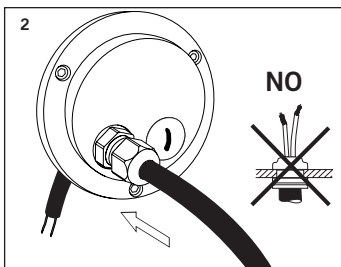
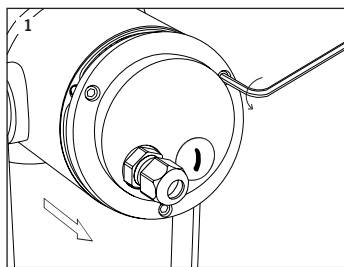

**4**  **THE CABLE MUST BE UNSHEATHED EXCLUSIVELY INSIDE THE BOX CONTAINING THE TERMINAL BLOCK**

**IL CAVO DEVE ESSERE SGUAINATO SOLO ALL'INTERNO DELL'APPOSITA SCATOLA CONTENENTE LA MORSETTIERA**

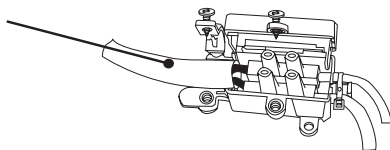

**CLASS II**

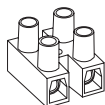

<b>(L)</b> → <b>L</b>	Life / Linea / Leitung Ligne / Linea / Fas Fase / Фаза / Vaihe Linha	Brown / Marrone / Braun Brun / Marrón / Brun Bruin / коричневый / Ruskea Marrom
<b>(N)</b> → <b>N</b>	Neutral / Neutro / Null Neutre / Neutro / Nolla Nul / Ноль / Nolla Neutro	Blue / Blu / Blau Bleu / Azul / Blá Blauw / синий / Sininen Azul

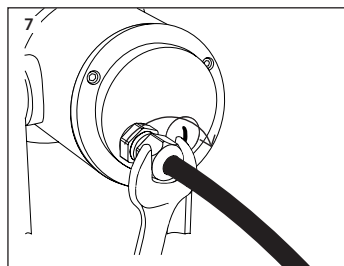
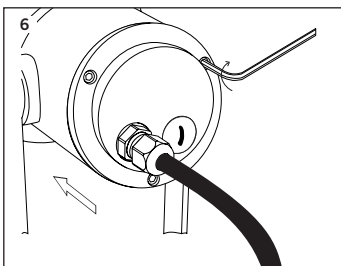
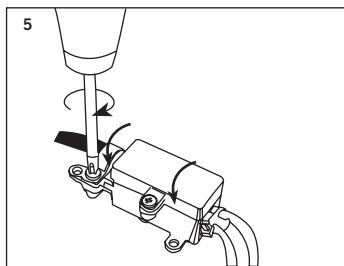

**INSERT THE LAMP - NO FOR LED VERSIONS  
 INSERIMENTO LAMPADINA - NO PER VERSIONI LED**

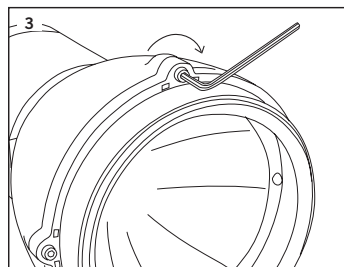
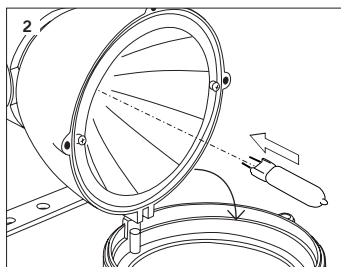
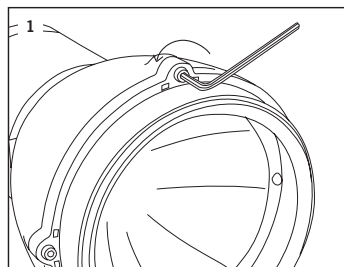

# INSTALLATION AND WIRING INSTALLAZIONE E CABLAGGIO INSTALLATION ET CÂBLAGE

# SIMES

## FIXING AND REGULATION FISSAGGIO E REGOLAZIONE

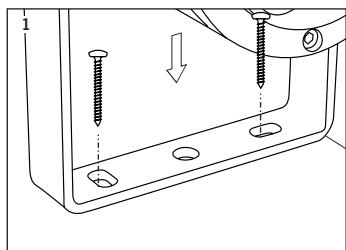

## DIMENSIONS OF THE FIXATION BRACKETS DIMENSIONI DELLE STAFFE DI FISSAGGIO

**MICROFOCUS**  
 98x22 mm

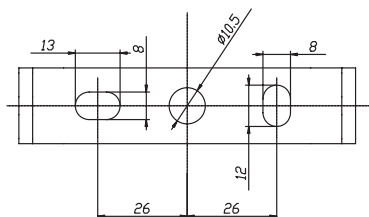

**MINIFOCUS**  
 149x30 mm

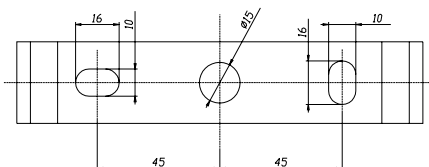

**FOCUS**  
 203x40 mm

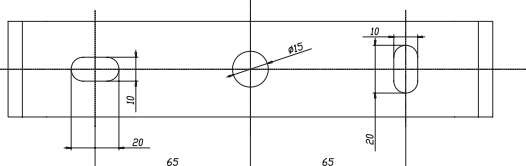

**MEGAFOCUS**  
 238x50 mm

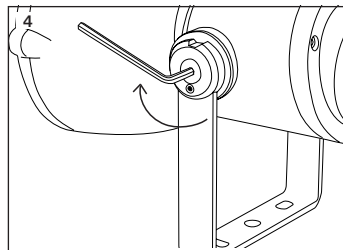
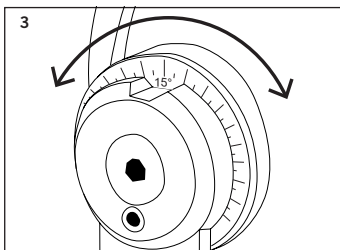
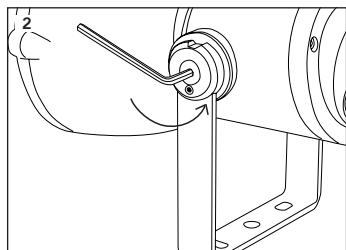
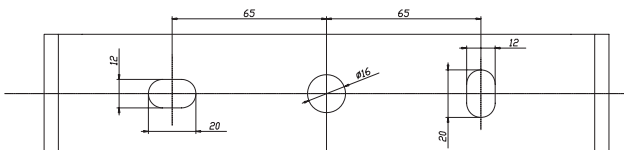

## LENSES AND COLOURED FILTER INSTALLATION INSTALLAZIONE LENTI E FILTRO COLORATO

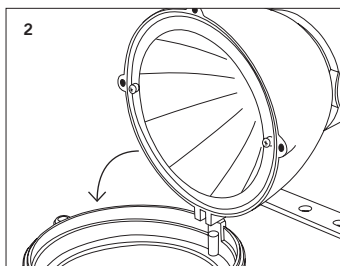
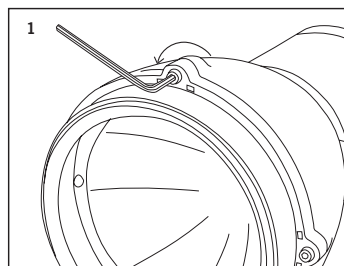

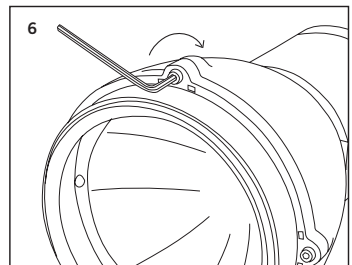
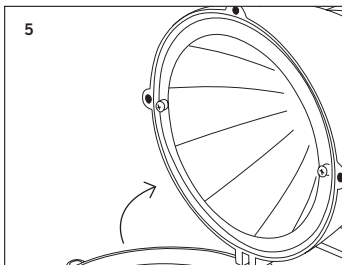
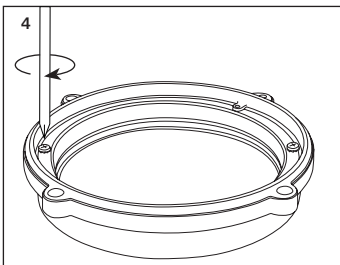
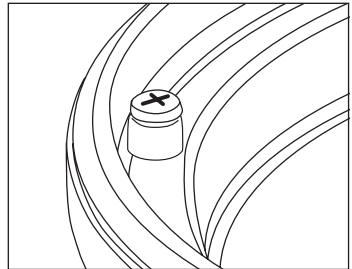
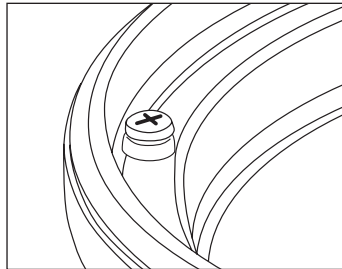
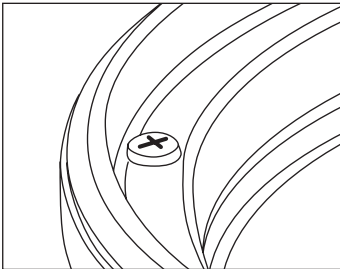
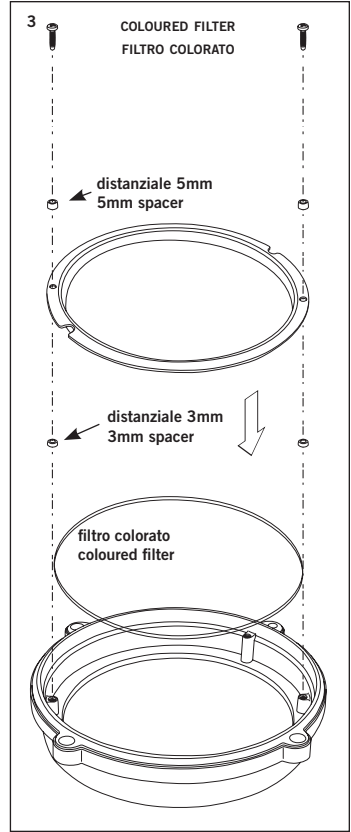
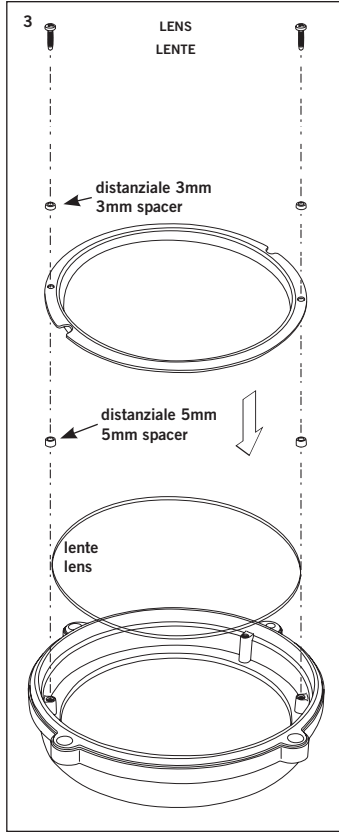
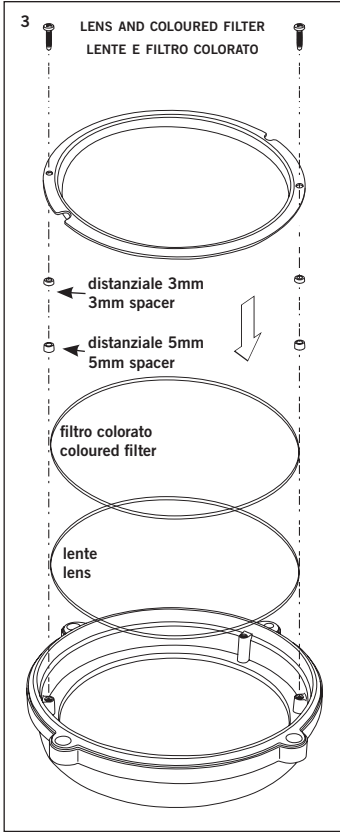

**VISOR INSTALLATION  
INSTALLAZIONE VISIERA**

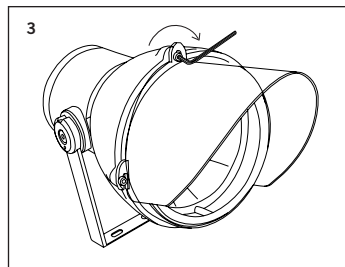
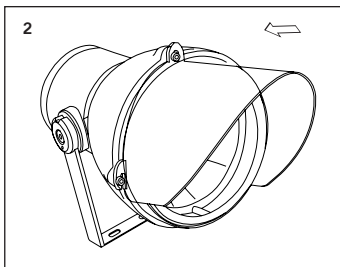
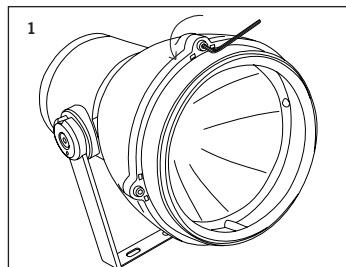

**ANTI GLARE SHIELD INSTALLATION  
INSTALLAZIONE FILTRO ANTIABBAGLIAMENTO**

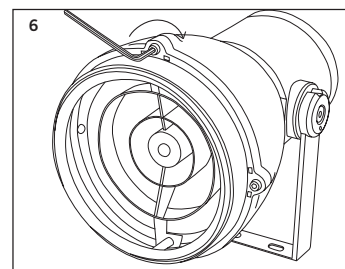
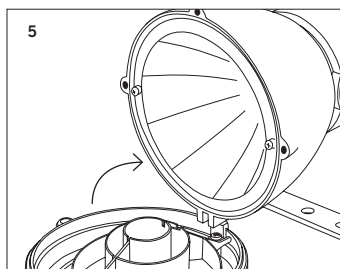
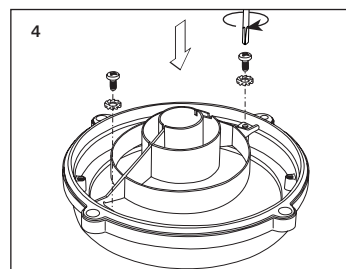
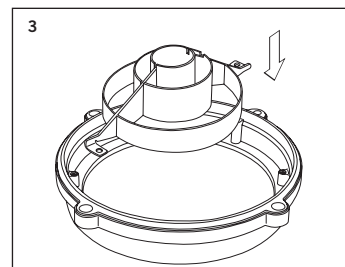
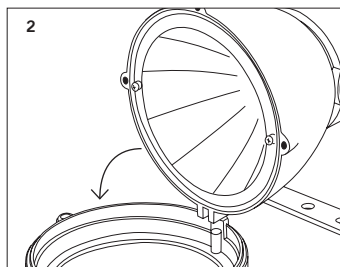
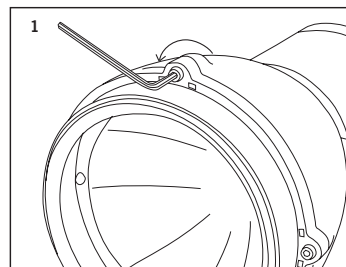

**ADJUSTABLE FLAPS INSTALLATION  
INSTALLAZIONE ALETTE PARALUCE ORIENTABILI**

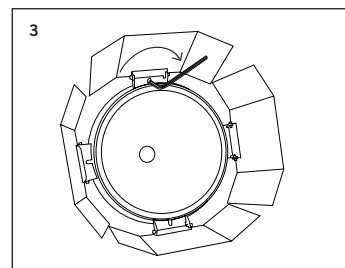
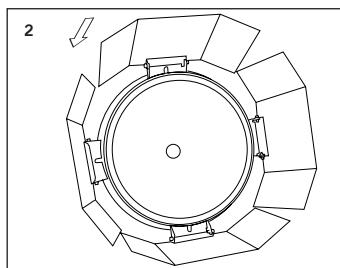
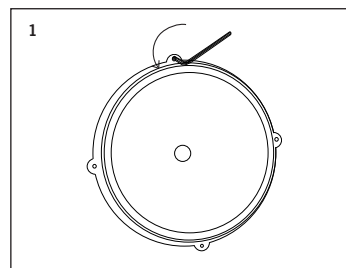



A large, empty rectangular box with a thin black border, occupying the majority of the page. It is intended for the user to write their notes.

A large, empty rectangular box with a thin black border, occupying the majority of the page. It is intended for the student to write their notes.

A large, empty rectangular box with a thin black border, occupying the majority of the page. It is intended for the student to write their notes.



- GB Directive 2002/96/CE (Waste Electrical and Electronic Equipment - WEEE):  
Information for users**  
The crossed out wheeled bin label that can be found on your product indicates that this product should not be disposed of via the normal household waste stream. To prevent possible harm to the environment or human health please separate this product from other waste streams to ensure that it can be recycled in an environmentally sound manner. For more details on available collection facilities please contact your local government office or the retailer where you purchased this product.
- I DIRETTIVA 2002/96/CE (Rifiuti di Apparecchiature Elettriche ed Elettroniche - RAEE):  
informazioni agli utenti**  
L'etichetta con il cassonetto barrato presente sul prodotto indica che il prodotto non deve essere smaltito tramite la procedura normale di smaltimento dei rifiuti domestici. Per evitare eventuali danni all'ambiente e alla salute umana separare questo prodotto da altri rifiuti domestici in modo che possa venire riciclato in base alle procedure di rispetto ambientale. Per maggiori dettagli sui centri di raccolta disponibili, contattare l'ufficio governativo locale o il rivenditore del prodotto.
- D Richtlinien 2002/96/EU (Elektro- und Elektronik- Altgeräte - WEEE):  
Benutzerinformationen**  
Der Aufkleber mit durchgekrenzter Mülltonne an diesem Produkt weist darauf hin, dass dieses Produkt nicht im normalen Hausmüll entsorgt werden darf. Zur Vermeidung einer möglichen Beeinträchtigung der Umwelt oder der menschlichen Gesundheit darf dieses Produkt nicht in den Hausmüll gegeben werden, um zu gewährleisten, dass es in einer umweltverträglichen Weise recycelt wird. Wenden Sie sich für Informationen zu Entsorgungseinrichtungen an die zuständige Behörde oder das Geschäft, in dem Sie dieses Produkt erworben haben.
- F Directive 2002/96/CE (Déchets d'équipements électriques et électroniques - DEEE):  
informations aux utilisateurs**  
L'étiquette apposée sur ce produit et représentant une poubelle à roulettes rayée indique que le produit ne peut être mis au rebut avec les déchets domestiques normaux. Afin d'éviter d'éventuels dommages au niveau de l'environnement ou de la vie humaine, veuillez séparer ce produit des autres déchets de manière à garantir qu'il soit recyclé de manière sûre au niveau environnemental. Pour plus de détails sur les sites de collecte existants, veuillez contacter l'administration locale ou le détaillant auprès duquel vous avez acheté ce produit.
- E Directiva 2002/96/CE (Residuos de aparatos eléctricos y electrónicos - RAEE):  
Información para el usuario**  
La etiqueta de un contenedor tachado que hallará en su producto indica que este producto no se puede tirar con la basura doméstica normal. Para impedir posibles daños medioambientales o para la salud, separe este producto de otros canales de desecho para garantizar que se recicle de una forma segura para el medio ambiente. Para más información sobre las instalaciones de recolección disponibles, diríjase a las autoridades locales o al punto de venta donde adquirió este producto.
- SE Directive 2002/96/CE (Waste Electrical and Electronic Equipment - WEEE):  
information for users**  
Symbolen med en överkorsad soptunna innebär att denna produkt inte får kastas i vanligt hushållsavfall. För att skydda miljön och hälsan bör denna produkt inte kastas tillsammans med vanligt hushållsavfall utan lämnas för återvinning på tillbörligt sätt. För mer information om uppsamlingsplatser, kontakta en lokal myndighet eller den återförsäljare som du köpte produkten från.
- NL Richtlijn 2002/96/EG (Afgedankte Elektrische en Elektronische Apparaten - AEEA):  
informatie voor de gebruikers**  
Op uw product is een label van een rolcontainer met een kruis erdoor aangebracht. Dit wil zeggen dat dit product niet bij het normale huishoudelijk afval mag worden gedaan. Om eventuele schade aan het milieu of de gezondheid van de mens te voorkomen moet dit product gescheiden van al het ander afval worden ingezameld, zodat het op een verantwoorde wijze kan worden verwerkt. Voor meer informatie over uw lokale afvalinzameling wendt u zich tot uw gemeente of de leverancier bij wie u dit product hebt gekocht.
- PL Dyrektywa 2002/96/CE (WEEE - ang. Waste Electrical and Electronic Equipment):  
informacje dla użytkowników**  
Użycie symbolu WEEE oznacza, że niniejszy produkt nie może być traktowany jako odpad domowy. Zapewniając prawidłową użycie pomogą chronić środowisko naturalne. W celu uzyskania bardziej szczegółowych informacji dotyczących recyklingu niniejszego produktu należy skontaktować się z przedstawicielem władz lokalnych, dostawcą usług utylizacji odpadów lub sklepem, gdzie nabyto produkt.
- FI Directive 2002/96/CE (Waste Electrical and Electronic Equipment - WEEE):  
information for users**  
WEEE-merkintä osoittaa, että tätä tuotetta ei voi käsitellä kotitalousjätteen tavoin. Kun huoletdit tämän tuotteen asianmukaisesta hävittämisestä, autat suojelemaan ympäristöä. Lisätietoja tämän tuotteen kierrättämisestä saat paikallisviranomaisilta, jättehuoltoyhtiöltä tai myymälästä, josta osit tämän tuotteen.
- PT Directiva 2002/96/CE (Resíduos de equipamentos eléctricos e electrónicos - REEE):  
informações para os utilizadores**  
A etiqueta com o símbolo de um contentor de lixo barrado com uma cruz que aparece no produto indica que este produto não deve ser deixado fora juntamente com o lixo doméstico. Para evitar possíveis danos no ambiente ou na saúde pública, por favor separe este produto de outros lixos; desta forma, terá a certeza de que pode ser reciclado através de métodos não prejudiciais ao ambiente. Para obter mais informações sobre os locais de recolha de lixo disponíveis, contacte a sua junta de freguesia ou o local onde comprou este produto.
-  This information only applies to customers in the European Union, according to Directive 2002/96/EC OF THE EUROPEAN PARLIAMENT AND OF THE COUNCIL OF 27 January 2003 on waste electrical and electronic equipment (WEEE) and legislation transposing and implementing it into the various national legal systems.



SIMES S.p.A. VIA G. PASTORE 2/4 - 25040 CORTE FRANCA (BRESCIA) - ITALY

TEL. +39 0309860430 - FAX +39 0309860439

E-mail: [simes@simes.it](mailto:simes@simes.it) - <http://www.simes.it>