

SIMES















luce per l'architettura



REMOTE DALI IP55 RGBW CONSTANT VOLTAGE POWER SUPPLY BOX

ISTBOXRGBW24DA
REV.0 - 07/22



 	S.3415	S.3416
	 	 
W	60W	90W
 W settings	-	-
 AC	220-240V	220-240V
Hz	50/60 Hz	50/60 Hz
 DC	-	127-431Vdc
V_{out}	24Vdc	24Vdc
CL	II	II
 IP	IP55	IP55
T_a	-10 ÷ +50°C	-10 ÷ +50°C
 DIMMABLE	DALI (DT6)	DALI (DT6)
SELV		
 Kg	1,300 Kg	1,800 Kg



S.3415
S.3416

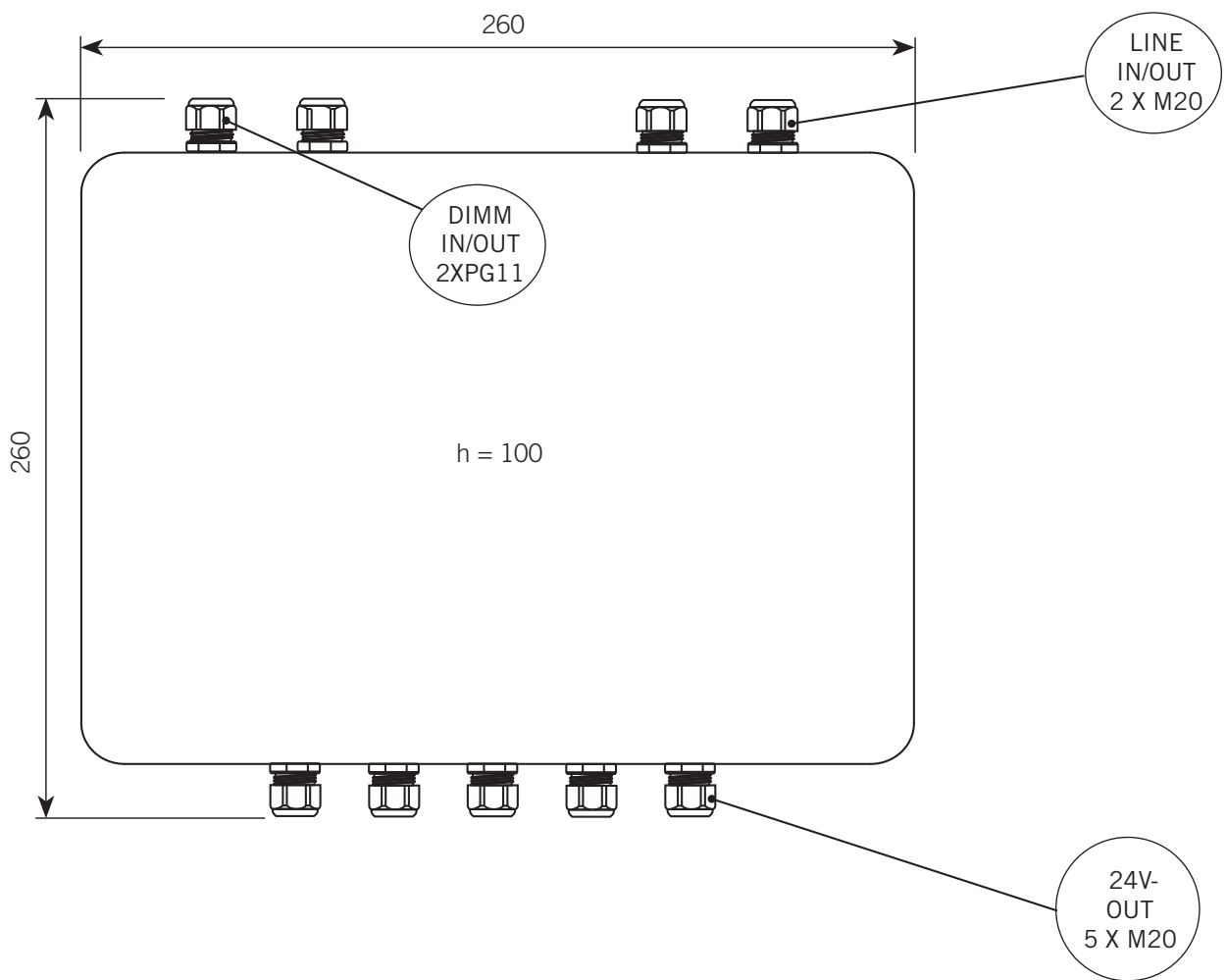



S I M E S S.XXXX

CE

CL

MADE IN ITALY
XXXX XXXX

IPXX

- GB Technical data on the internal label.
I Dati tecnici sulla etichetta interna.
D Technische Daten auf der internen Bezeichnung.
F Données techniques sur l'étiquette interne.
E Datos técnicos en la etiqueta interna.

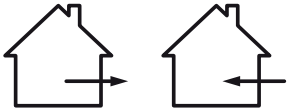

- GB The article is suitable for outside and inside use.
I Prodotto idoneo all'uso esterno ed interno.
D Artikel ist geeignet zur zußerlichen und inneren Anwendung.
F L'article est adapte pour usage externe et interne.
E Producto adecuado para uso en exteriores y en interiores.

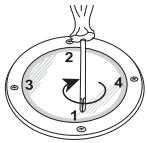

- GB Lock and unlock the screws following an alternate sequence.
I Bloccare e sbloccare le viti di chiusura con sequenza alternata.
D Die Verschlusschrauben kreuzweise anziehen bzw. lösen.
F Bloquer et débloquer les vis de fermeture "en croix", par séquence alternée.
E Abrir y cerrar los tornillos en secuencia alterna.

- GB Install the device in an easily accessible place. Do not expose to direct sunlight and to bad weather.
I Installare il dispositivo in un luogo facilmente accessibile. Non esporre ai raggi diretti del sole e alle intemperie.
D Installieren Sie das Gerät in einem leicht zugänglichen Ort. Sie nicht direkter Sonneneinstrahlung und dem schlechten Wetter ausgesetzt werden.
F Installez l'appareil dans un endroit facilement accessible. Ne pas exposer à la lumière solaire directe et aux intempéries.
E Instalar el dispositivo en un lugar fácilmente accesible. No exponga a la luz solar directa y al mal tiempo.

DALI

- GB The DALI control voltage is a functional extra-low voltage (FELV). During installation, ensure the basic insulation between the main power supply line (LV) and the BUS DALI control conductors.
I La tensione di comando DALI è una bassissima tensione funzionale (FELV). Durante l'installazione, mantenere l'isolamento principale tra la linea di alimentazione (LV) ed i conduttori di controllo BUS DALI.
D Die DALI-Steuerspannung ist eine funktionale Niederspannung (FELV). Während der Installation die Hauptisolation zwischen der Stromleitung (LV) und den DALI BUS-Steuereleitern aufrechterhalten.
F La tension de commande DALI est une très basse tension fonctionnelle (FELV). Pendant l'installation, maintenir l'isolation principale entre la ligne d'alimentation (BT) et les conducteurs de commande DALI BUS.
E La tensión de control DALI es una tensión muy baja funcional (FELV). Durante la instalación, mantenga el aislamiento principal entre la línea de alimentación (BT) y los conductores de control del BUS DALI.

GB
I
D
F
E



GB Electronic equipment sensitive to **overvoltage**. **We recommend installing surge protection devices “SPD” in the electrical system.**

Protection devices prevent the intensity of these phenomena's, protecting the appliances from the risk of being damaged and extending the lifespan.

Outdoor luminaires are subject to all types of permanent, temporary, or transient electrical disturbances. Such disturbances can create permanent damage or failure affecting its performance and durability. The surge protection device (supplied by SIMES) is utilized to limit the destructive effect of these phenomena. We suggest that each luminaire must be connected to one protection device at not more than 10m away. For correct coordination of the protections, a surge protection device must also be provided inside the electrical panel of the system (the selection of this device must be carried out from the electrical designer and is not supplied by SIMES).

I Apparecchiature elettroniche sensibili a **sovratensione**. **Si raccomanda di installare nell'impianto elettrico dispositivi di protezione contro le sovratensioni “SPD”.**

I dispositivi di protezione prevengono l'intensità di questi fenomeni, proteggendo gli apparecchi dal rischio che vengano danneggiati e prolungandone la vita.

Gli apparecchi di illuminazione per esterni sono soggetti a tutti i tipi di disturbi elettrici permanenti, temporanei o transitori. Tali disturbi possono creare danni permanenti o guasti che ne compromettono le prestazioni e la durata. Il dispositivo di protezione da sovratensioni (forniti da SIMES) è utilizzato per limitare l'effetto distruttivo di questi fenomeni. Deve essere previsto per ogni apparecchio di illuminazione, un dispositivo di protezione ad una distanza non superiore a 10m.

Per un corretto coordinamento delle protezioni deve essere previsto anche un dispositivo di protezione contro le sovratensioni all'interno del quadro elettrico di alimentazione dell'impianto (la scelta di quest'ultimo è a carico del progettista e non è fornito da SIMES).

D **Überspannungsempfindliche** elektronische Geräte. **Wir empfehlen den Einbau von Überspannungsschutzgeräten „SPD“ in die elektrische Anlage.**

Schutzvorrichtungen verhindern die Intensität dieser Phänomene, schützen die Geräte vor dem Risiko, beschädigt zu werden, und verlängern die Lebensdauer. Außenleuchten sind allen Arten von permanenten, temporären oder transienten elektrischen Störungen ausgesetzt. Solche Störungen können zu dauerhaften Schäden oder Ausfällen führen, die die Leistung und Haltbarkeit beeinträchtigen. Die Überspannungsschutzvorrichtung (von SIMES geliefert) wird verwendet, um die zerstörerische Wirkung dieser Phänomene zu begrenzen. Wir schlagen vor, dass jede Leuchte an ein Schutzgerät in nicht mehr als 10 m Entfernung angeschlossen werden muss. Für eine korrekte Koordination der Schutzvorrichtungen muss auch eine Überspannungsschutzvorrichtung innerhalb der Schalttafel des Systems vorhanden sein (die Auswahl dieses Geräts muss vom Elektrokonstrukteur durchgeführt werden und wird nicht von SIMES geliefert).



F Matériel électronique sensible aux **surtensions**. **Nous recommandons d'installer des dispositifs de protection contre les surtensions “SPD” dans le système électrique.**

Des dispositifs de protection préviennent l'intensité de ces phénomènes, protégeant les appareils des risques d'endommagement et prolongeant leur durée de vie. Les luminaires extérieurs sont soumis à tous types de perturbations électriques, permanentes, temporaires ou transitoires. De telles perturbations peuvent créer des dommages permanents ou des défaillances affectant ses performances et sa durabilité. Le parafoudre (fourni par SIMES) est utilisé pour limiter l'effet destructeur de ces phénomènes. Nous suggérons que chaque luminaire soit connecté à un dispositif de protection à une distance maximale de 10 m. Pour une bonne coordination des protections, un dispositif de protection contre les surtensions doit également être prévu à l'intérieur du tableau électrique de l'installation (le choix de ce dispositif doit être effectué auprès du concepteur électrique et n'est pas fourni par SIMES).

E Equipos electrónicos sensibles a **sobretensiones**. **Recomendamos instalar dispositivos de protección contra sobretensiones “SPD” en el sistema eléctrico.**

Los dispositivos de protección previenen la intensidad de estos fenómenos, protegiendo los aparatos del riesgo de sufrir daños y alargando la vida útil.

Las luminarias de exterior están sujetas a todo tipo de efectos permanentes, temporales o transitorios.

perturbaciones eléctricas. Tales perturbaciones pueden crear daños permanentes o fallas que afecten su desempeño y durabilidad. El dispositivo de protección contra sobretensiones (suministrado por SIMES) se utiliza para limitar el efecto destructivo de estos fenómenos. Sugerimos que cada luminaria debe estar conectada a un dispositivo de protección a no más de 10 m de distancia. Para una correcta coordinación de las protecciones, también se debe prever un dispositivo de protección contra sobretensiones en el interior del cuadro eléctrico del sistema (la selección de este dispositivo debe ser realizada por el diseñador eléctrico y no es suministrado por SIMES).

**GB ANY MODIFICATION TO THIS FITTING IS FORBIDDEN WITHOUT AUTHORIZATION !**

The safety of the fitting is guaranteed only respecting the electrical European norms and the mounting instructions in this box; therefore it is important to conserve them. The respect of these instructions is very important for the fitting and for the electrical system.

Installation should be carried out by a suitable qualified person in accordance with good electrical practice and the appropriate national wiring regulations.

Do not use lamps with higher power than indicated.

Disconnect main voltage before maintenance operations.

I OGNI MODIFICA DELL'APPARECCHIO E' PROIBITA SENZA PREVIA AUTORIZZAZIONE !

La sicurezza dell'apparecchio è garantita solo rispettando le normative europee del settore elettrico e le istruzioni contenute in questa scatola; pertanto è necessario conservarle. Il rispetto di queste istruzioni è fondamentale per il corretto funzionamento dell'apparecchio e dell'impianto.

L'installazione deve essere fatta da personale qualificato.

Non utilizzare lampade di potenza superiore al limite indicato.

Togliere tensione prima di eseguire le operazioni di manutenzione.

D JEDE UNBEFUGTE ÄNDERUNG AN DIESER LEUCHE IST VERBOTEN !

Die Sicherheit der Leuchte ist nur bei Einhaltung der europäischen Normen und der in dieser Packung enthaltenen Montageanleitungen gewährleistet. Diese sind daher sorgfältig aufzubewahren.

Diese Anweisungen sind daher unbedingt einzuhalten, um die Funktionsfähigkeit dieser Leuchte und der Beleuchtungsanlage sicherzustellen. Bitte sorgfältig aufbewahren.

Keine Lampen höherer Leistung als angegeben verwenden.

Diese Leuchte muss fachmännisch installiert werden.

Vor Wartungsarbeiten die Leuchte vom Netz trennen.

F TOUTE MODIFICATION DE CET APPAREIL, SANS AUTORISATION, EST INTERDITE !

La sécurité des appareils est garantie uniquement en respectant les normes électriques européennes et les instructions contenues dans l'emballage; aussi est-il nécessaire de les conserver. Le respect de ces instructions est fondamental pour un fonctionnement correct de l'appareil et de l'implantation électrique et doit être suivi scrupuleusement.

Ne pas utiliser des puissances de lampes supérieures à la limite indiquée.

L'installation doit être effectuée par des personnes qualifiées.

Couper l'alimentation avant d'exécuter toute manutention.

E CUALQUIER MODIFICACION DE LOS APARATOS ESTA PROHIBIDA SIN AUTORIZACION !

La seguridad de los aparatos está garantizada solamente respetando las normas eléctricas Europeas y las instrucciones de montaje incluidas en la caja, por lo tanto es importante conservarlas. El respeto de estas instrucciones es fundamental para el correcto funcionamiento del aparato y de la instalación.

La instalación debe hacerla personal calificado.

No usar lámparas de potencia superior a la indicada.

Desconectar la alimentación principal antes de continuar las operaciones de mantenimiento.

SE ALL OMBYGGNAD AV DENNA ARMATUR ÄR FÖRBUDEN !

Säkerheten av och garantin för armaturen gäller endast om man följer det Europeiska elektriska normerna samt följer den till armaturen bifogade monteringsanvisningen; därför är det viktigt att spara den.

Installation får endast utföras av behörig person i enlighet med god elektrisk installationssed och nationella installationsregler.

Använd ej högre effekt än angivet. Koppla från armaturen före allt underhåll.

NL ALLE NIET VOORAF TOEGESTANE WIJZIGINGEN AAN DIT TOESTEL ZIJN VERBODEN !

Uitsluitend op basis van de geldende Europeesche normen, en de montagehandleiding in deze doos kunnen wij de veiligheid van de armatuur garanderen. Het is daarvoor van belang deze goed te bewaren. Het respecteren van deze instructies is van belang voor de levensduur van de installatie.

De installatie moet worden uitgevoerd door een goed gekwalificeerd persoon met de juiste opleiding, en op basis van de nationale regelgeving m.b.t. bedraden.

Gebruik geen lampen met hogere wattages dan aangegeven.

Sluit de voedingsspanning af voor onderhoud.

RU ЛЮБЫЕ ИЗМЕНЕНИЯ КОНСТРУКЦИИ СВЕТИЛЬНИКА БЕЗ СОГЛАСОВАНИЯ ЗАПРЕЩАЮТСЯ !

Безопасность светильника гарантирована только при соблюдении электрических норм и правил (ПУЭ), а также инструкции по установке светильника, которая находится в коробке. Поэтому очень важно сохранить их.

Установка должна осуществляться квалифицированным электриком, имеющим опыт установки подобного оборудования, а также имеющим соответствующий допуск к работам.

Do not use lamps with higher power than indicated.

Не используйте источники света мощностью выше обозначенной.

FI KAIKENLAISET VALAISIMEN MUUTOSTYÖT ILMAN VALMISTAJAN SUOSTUMUSTA OVAT KIELLETTYJÄ!

Valaisimen käyttöturvallisuutta ei taata, mikäli valaisinta ei ole asennettu pakkauksessa tulleiden ohjeiden mukaisesti ja käytetty Eurooppalaisten normien mukaisesti; näin ollen on tärkeää säilyttää nämä ohjeet. Valaisimen ja syöttökaapelin käyttöikää ajatellen näiden ohjeiden noudattaminen on ensiarvoisen tärkeää.

Asennustyö on suoritettava valtuutetun sähköasentajan toimesta.

Käytä vain arvokilvessä mainittua lampputyyppeä.



P QUALQUER ALTERAÇÃO NESTE APARELHO, SEM AUTORIZAÇÃO, É INTERDITA !

A segurança das luminárias é garantida somente se as normas eléctricas Europeias forem respeitadas bem como as instruções de montagem que estão na embalagem. É necessário conservá-las após montagem. A observação das instruções é fundamental para um funcionamento correcto da mesma e a ligação eléctrica deve ser seguida escrupulosamente.

A instalação deve ser executada só por pessoal qualificado.

Não utilizar lâmpadas com potência superior ao limite indicado.

Cortar a alimentação antes de executar a manutenção.

GB GENERAL MAINTENANCE RECOMMENDATIONS

A scheduled maintenance programme must be carried out on the installation and the fittings regardless of their IP rating or application – these must include the following operations:

- clean the fittings from dirt that may be deposited on the protection grills and in the heads of the screws by following the installation instructions attached to each fitting.
- Check that the screws are not loose on the various components of the luminaire (glass frame, cable entry , ...).
- Check each cable gland, and cable for damage and that the cable gland has not come loose.
- For each Isolation Class 1 fitting check that the earth cable has not come loose. The clip must not show signs of oxidation, damage or become loose.
- For class 2 fittings check any eventual plastic / isolating covering in order to verify any damage.
- Check that all the seals are in good condition and that they are not dry, damaged or split.
- Check the glass or plastic screen for damage and replace if required.
- Check for water inside the luminaire's housing and its recessing box.

The internal components such as the ballasts, transformers, washers and screws must not show clear signs of oxidation or rust. Clear traces of rust and oxidation will indicate the presence of water inside the luminaire.

In case of damage the components must be replaced by original components and spare parts before using the fitting. We also recommend to check the fitting each time the lamp is replaced or at least once a year or within the prescribed maintenance schedule period depending on the type of installation.

I RACCOMANDAZIONI GENERALI PER LA MANUTENZIONE

Per tutti gli apparecchi di illuminazione al di là della classe di appartenenza e del tipo di utilizzo deve essere effettuata a cadenza programmata la manutenzione dell'installazione che deve prevedere almeno le seguenti operazioni:

- Pulire periodicamente gli apparecchi per rimuovere gli accumuli di sporco che si possono depositare sulle griglie e nella testa delle viti seguendo le ulteriori indicazioni riportate sulle istruzioni di montaggio allegate con ogni apparecchio.
- Verificare il serraggio delle viti che fissano le varie parti dell'apparecchio (cornice vetro, vano di ingresso cavo, ecc.).
- Verificare l'integrità di tutti i pressacavi e dei cavi. Verificare il serraggio dei pressacavi.
- Per gli apparecchi in classe I verificare il serraggio del filo di terra all'apparecchio; il morsetto non deve presentare allentamento né ossidazione o danni di qualsiasi tipo. Se il caso serrare a fondo la vite del morsetto.
- Per gli apparecchi in classe II verificare eventuali involucri plastici/isolanti, allo scopo di individuare eventuali danni agli isolamenti.
- Verificare l'integrità e l'elasticità delle guarnizioni, che non devono risultare: Secche, Pizzicate, Interrotte o Danneggiate.
- Verificare l'integrità dello schermo in vetro o plastico. Sostituirlo in caso di rottura o danneggiamento.
- Verificare l'eventuale accumulo di acqua all'interno dell'apparecchio o della cassaforma.

I componenti interni come l'alimentatore, il trasformatore, la morsettiera, ecc. non devono presentare segni consistenti di ruggine o di ossidazione. La presenza di tali segnali indica una possibile penetrazione di acqua all'interno dell'apparecchio.

In caso di componenti danneggiati essi vanno sostituiti prima di rimettere in servizio l'apparecchio utilizzando solo ricambi originali.

Si consiglia di effettuare controlli ad ogni sostituzione di lampada o almeno ogni anno scegliendo il periodo più breve in relazione al tipo di impianto.

D GENERELLE WARTUNGSEMPFEHLUNGEN

Ein geplantes Wartungsprogramm sollte für die Installation einer jeden Beleuchtungsanlage, unabhängig von der IP Schutzart oder Anwendung ausgearbeitet werden.

Dabei sind die folgenden Punkte unbedingt durchzuführen:

- Reinigen Sie die Leuchten von Schmutz, der sich in allen Bereichen abgesetzt haben könnte. Berücksichtigen Sie dabei auch die Schraubenköpfe sowie die Komponenten des Zubehörs, wie z. B. Schutzgitter gemäß den Angaben der im Lieferumfang beigefügten Montageanleitung
- Stellen Sie sicher, dass sich Befestigungsschrauben an der Leuchte selbst oder an Zubehörteilen nicht gelöst oder gelockert haben (z.B. auch an Abdeckgläsern oder Kabeleinführungen).
- Überprüfen Sie die Kabeleinführung auf festen Sitz und sämtliche Zuleitungen auf mögliche Verletzungen des Schutzmantels
- Bei Leuchten der elektrischen Schutzklasse I ist sicherzustellen, dass die Erdungsleitung fest sitzt. Die Erdungslaschen selbst dürfen keine Spuren von Korrosion aufweisen.
- Bei Leuchten der elektrischen Schutzklasse II sind alle Plastikteile der doppelten Isolierung auf Brüche oder mögliche Verletzungen zu überprüfen
- Prüfen Sie sämtliche Formdichtungen auf Funktion und äußere Erscheinung bezüglich Versprödung, Austrocknung oder Zersplitterung
- Prüfen Sie die Abdeckungen auf Risse oder Bruch und Ersetzen sie diese im Schadensfall.
- Prüfen Sie die Leuchten- und Eingießgehäuse auf Wassereinfall

Sämtliche sich in der Leuchte befindenden Komponenten wie Vorschalt- oder Netzgeräte, Unterleg- oder Zahnscheiben dürfen keine Anzeichen von Rost oder Oxidation aufzeigen.



Diese Anzeichen signalisieren eindeutig, dass sich Feuchtigkeit innerhalb der Leuchte befindet. Sollten Komponenten innerhalb der Leuchte defekt oder gebrochen sein, so müssen sie durch Original Ersatzteile fachgerecht ersetzt werden, bevor die Leuchte in Betrieb gehen kann. Wir empfehlen weiterhin, die Leuchte je nach Anwendungsfall und Installationsart auf den termingerechten Leuchtmittelwechsel bei der Wartungsarbeit zu überprüfen und die vorgegebenen Intervalle der Leuchtmittel Lieferanten einzuhalten.

F RECOMMANDATIONS GENERALES POUR L'ENTRETIEN

Pour tous les appareils d'éclairage à part la classe à laquelle ils appartiennent et le type d'utilisation, un entretien à échéance programmée doit être effectuée; il doit prévoir au moins les opérations suivantes:

- nettoyer périodiquement les appareils et enlever les accumulations de saleté qui peuvent se déposer sur les grilles et les vis en suivant les indications supplémentaires dans les notices d'instructions qui accompagnent chaque appareil
- Vérifier le serrage des vis qui fixent les différentes parties de l'appareil (enjoliveur de la verrière, entrée câble etc.)
- Vérifier le parfait état de tous les presse-étoupes et des câbles. Vérifier le serrage des presse-étoupes.
- Pour les appareils de Classe I vérifier le serrage du fil de mise-à-la-terre de l'appareil: le domino ne peut présenter de détachement ou de mauvaises conditions de quelque nature qu'il soit. Au besoin, serrer à fond la vis de fixation du domino.
- Pour les appareils de Classe II vérifier les enveloppes éventuelles en plastique ou isolants afin d'identifier des dégâts aux isolations
- Vérifier le parfait état et l'élasticité des joints qui ne peuvent pas se présenter comme secs, pincés, interrompus ou endommagés
- Vérifier le parfait état de l'écran / du diffuseur en verre ou matière thermoplastique. Le remplacer en cas de casse ou d'endommagement
- Vérifier d'éventuels accumulations d'eau à l'intérieur de l'appareil ou du boîtier d'encastrement

Les composants internes tels que l'alimentateur, le transformateur, le domino etc. ne peuvent présenter des signes importants de rouille ou d'oxydation.

La présence de tels phénomènes signale une possible entrée d'eau à l'intérieur de l'appareil

En cas où des composants étaient endommagés, ceux-ci doivent être remplacés avec des pièces de rechange d'origine avant de remettre l'appareil en service.

Il est recommandé d'effectuer des contrôles lors de lu remplacement de la lampe ou au moins une fois par an en choisissant la période la plus courte en relation avec le type d'installation.

E RECOMENDACIONES GENERALES PARA EL MANTENIMIENTO

Para todas las luminarias en función del grado de protección así como de su uso, se debe efectuar un mantenimiento de las mismas

que tiene que incluir las siguientes operaciones:

- limpiar periódicamente las luminarias para quitar la suciedad que puede depositarse en la rejilla y en la cabeza de los tornillos siguiendo
- Las instrucciones de instalación que acompañan a cada luminaria
- verificar que los tornillos están debidamente apretados a las distintas partes de la luminaria (aro, entrada de cable...)
- verificar la integridad de todos los prensa cables y cables. Verificar que estén apretados los prensas.
- para las luminarias de clase I verificar la fijación del cable T.T, la regleta no debe presentar oxidación ni daños de cualquier tipo.
- para las luminarias de clase II verificar que no haya ninguna envoltura de plástico que pueda dañar la luminaria.
- verificar la elasticidad de la silicona, no tiene que estar ni seca, ni dañada ni rota.
- verificar la integridad de la cristal o del plástico. Sustituirlo en caso de rotura o daño.
- verificar de tanto en tanto la acumulación de agua en el interior de la luminaria o de la caja de empotrar.

Los componentes internos como el alimentador, transformador, regleta.. no deben estar oxidados.

La presencia de cortes indica una posible entrada de agua en el interior de la luminaria

En caso de componentes dañados deben sustituirse por recambios originales antes de volver a utilizarlos.

Se aconseja efectuar controles de cada luminaria al menos una vez al año o dentro del periodo recomendado por el mantenimiento de cada luminaria en función de la instalación.

SE ALLMÄNNA UNDERHÅLLSREKOMMENDATIONER

Schemalagt underhåll måste utföras på installationen och anslutningarna oavsett kapslingsklassning eller applikation. I underhållet måste följande åtgärder ingå:

- Rengör anslutningarna från smuts som kan ha ansamlats på skyddsgallren och på skruvhuvudena genom att följa installationsanvisningarna som sitter på varje anslutning.
- Kontrollera att skruvarna inte sitter löst på de olika komponenterna i armaturen (glasram, kabelinföring, ...).
- Kontrollera varje kabelförskruvning, att kabeln inte är skadad och att förskruvningen inte sitter löst.
- Kontrollera på varje isoleringsklass 1-anslutning att jordkabeln inte sitter löst. Klämman får inte sitta löst eller visa tecken på oxidering eller skada.
- Kontrollera på klass 2-anslutningar alla eventuella plast- och isoleringshöljen för skador.
- Kontrollera att alla tätningar är i bra skick och inte är torra, skadade eller spruckna.
- Kontrollera glas- eller plastskärmen för skador och byt ut den vid behov.
- Kontrollera att det inte finns vatten innanför armaturens hölje och infällnadsbox.

De interna komponenterna, såsom ballaster, transformatorer, brickor och skruvar, får inte visa tydliga tecken på oxidering eller rost. Tydliga tecken på rost och oxidering tyder på förekomst av vatten inuti armaturen.

Vid skada måste komponenterna ersättas med originalkomponenter och reservdelar innan anslutningen används.

Vi rekommenderar även att kontrollera anslutningen varje gång lampan ersätts eller åtminstone en gång om året eller inom tidsintervallet på det föreskrivna underhållsschemat beroende på typ av installation.



NL ALGEMENE ONDERHOUDSINSTRUCTIES

De installatie en de armaturen moeten, ongeacht hun IP-waarde of toepassing, onderhouden worden volgens een regelmatig onderhoudsprogramma. Hierbij moeten onderstaande handelingen uitgevoerd worden:

- verwijder vuil van de beschermroosters en in de koppen van de schroeven van de armaturen; volg hiervoor de instructies voor installatie voorzien bij elk armatuur;
- controleer of de schroeven, voorzien op de verschillende onderdelen van het armatuur (glasframe, kabelinvoer, enz.) goed vastzitten;
- controleer elke kabelwartel en kabel op schade; controleer of de kabelwartel niet losgekomen is;
- controleer voor elk armatuur van veiligheidsklasse 1 of de aardingskabel niet losgekomen is. De klem mag geen tekenen van roest/oxidatie en/of schade vertonen en mag niet losgekomen zijn;
- controleer de plastic of isolerende afdekking van de armaturen van veiligheidsklasse 2, op schade;
- controleer of alle dichtingen in goede staat zijn, en niet droog, beschadigd of gebarsten;
- controleer de glazen of plastic afdekking op schade en vervang indien nodig;
- controleer of er geen waterinsijpeling is in de behuizing van de armatuur en de inbouwdoos.

De interne onderdelen zoals de ballasten, transformers, sluitringen en schroeven mogen geen duidelijke tekenen van oxidatie of roest vertonen. Roest- en oxidatiesporen duiden op de aanwezigheid van water in het armatuur.

Indien de onderdelen beschadigd zijn, moeten ze vervangen worden door originele onderdelen en reservestukken vooraleer het armatuur wordt gebruikt.

We raden ook aan om de armaturen telkens te controleren wanneer de lamp vervangen wordt, of minstens 1 x per jaar, of binnen de voorgeschreven onderhoudsperiode, afhankelijk van het type installatie.

RU РЕКОМЕНДАЦИИ ПО ЭКСПЛУАТАЦИИ

Данные рекомендации по техническому обслуживанию должны соблюдаться при установке любых светильников, независимо от их сферы применения или степени защиты. Необходимо выполнить следующие операции:

- Очистите светильник, удалив загрязнения с защитной решетки и головок винтов, следуя инструкции по установке, прилагаемой к каждому светильнику.
- Проверьте затяжку винтов, соединяющих части светильника (стеклянную рамку, место ввода кабеля и пр.)
- Проверьте целостность и герметичность кабельных вводов.
- Для светильников с классом защиты 1: проверьте подвод заземляющего кабеля к корпусу на отсутствие признаков окисления или механических повреждений.
- Для светильников с классом защиты 2: убедитесь в целостности изоляционного покрытия.
- Проверьте защитное стекло на предмет повреждений и при необходимости замените.
- Убедитесь в отсутствии воды внутри корпуса светильника и коробки для встраивания.
- Убедитесь, что внутренние компоненты, такие как драйвер, трансформатор, зажимной блок и пр., не имеют следов окисления и ржавчины. Наличие таких признаков может быть результатом проникновения воды внутрь светильника.
- В случае повреждения компоненты следует заменить до включения прибора, используя только оригинальные запасные части.
- Мы рекомендуем проверять светильник по вышеописанному алгоритму при каждой замене источника света, как минимум раз в год или согласно расписанию проверки светильника, которое зависит от типа установки.

FI YLEISET HUOLTOSUOSITUKSET

Järjestelmälle ja sen komponenteille on laadittava huoltosuunnitelma järjestelmän IP-luokituksesta tai käyttöolosuhteista riippumatta. Suunnitelman tulee kattaa seuraavat toimenpiteet:

- Puhdista komponenttien suojaritilöihin ja ruuvinkantoihin ym. kertynyt lika kunkin tuotteen asennusohjeiden mukaisesti.
- Tarkasta ruuvien kireys valaisinten kaikista osista (lasikehykset, läpiviennit jne.).
- Tarkasta kaikkien läpivientitiivistysten eheys ja tiukkuus sekä kaapeleiden vauriottomuus.
- Eristysluokan 1 valaisimet: tarkasta maadoituskaapelin liitäntän tiukkuus. Liittimessä ei saa näkyä hapettumista eikä vaurioita, eikä liitäntä saa olla löysä.
- Luokan 2 valaisimet: tarkasta kaikkien valaisimissa mahdollisesti olevien muovi-/eristesuojusten kunto ja eheys.
- Tarkasta, että kaikki tiivisteet ovat hyväkuntoiset, joustavat, eheät ja vauriottomat.
- Tarkasta lasi- tai muovilevyt vaurioiden varalta ja vaihda tarvittaessa.
- Tarkasta, ettei valaisinkoteloiden tai asennuskehikoiden sisään ole päässyt kosteutta.

Valaisinten sisältämissä osissa, kuten liitäntälaitteissa, muuntajissa, aluslevyissä ja ruuveissa ei saa näkyä selviä merkkejä hapettumisesta tai ruosteesta. Selvät hapettumis- ja ruostemerkit tarkoittavat, että valaisimen sisälle on päässyt kosteutta. Vaurioituneet komponentit on korvattava alkuperäisillä komponenteilla ja varaosilla, ennen kuin valaisinten käyttöä jatketaan. Suosittelemme tarkastamaan valaisimet myös jokaisen lampunvaihdon yhteydessä tai vähintään yhden vuoden tai järjestelmän tyyppin mukaan määräytyvän muun määräajan välein.

P MANUTENÇÃO GERAL RECOMENDAÇÕES

Um programa de manutenção deve ser realizada na instalação e nas luminárias, independentemente da sua classificação de IP ou aplicação. O programa deve incluir as seguintes operações:

- Limpar o material proveniente da aplicação, terras que se podem depositar no anel da luminária e no vedante podendo afectar o IP da Luminária, ter também em consideração a zona de aperto dos parafusos, seguindo as instruções de instalação fornecidas com a luminária.
- Verifique se não existem parafusos soltos sobre os vários componentes da luminária (moldura de vidro, entrada do cabo,).
- Verifique da existencia de danos no cabo ou na sua camada isolante dos consutores. Certifique-se que o mesmo está devidamente fixo na zona de Bucin ou no passa fios, garantindo o IP da luminária.
- Para poder assegurar o Isolamento classe I deve-se certificar que o fio de terra fica devidamente fixo no local específico da luminária. A fixação não deve apresentar sinais de oxidação, danos ou se soltar.
- Para a assegurar a classe II deve-se verificar se por debaixo das partes isolantes as ligações de demais partes electricas se encontram nas devidas condições.



- Verifique se todos os vedantes estão em bom estado não apresentando sinais de estarem resequecidos ou danificados. Caso suceda devem ser colocados novos isolantes.
- Verifique o Difusor (Vidro; Policarbonato; metacrilato) se não apresenta nenhum dano, substituir se necessário..
- Verifique se existe água no interior da luminária e sua caixa de embutir.

Os componentes internos, como os reatores, transformadores, anilhas e parafusos não deve mostrar sinais claros de oxidação ou ferrugem.

Vestígios claros de ferrugem e oxidação irá indicar a presença de água no interior da luminária.

Em caso de danos os componentes devem ser substituídos por componentes originais e peças de reposição antes de dar uso à luminária.

Recomendamos também que se verifique a instalação cada vez que a lâmpada seja substituída ou, pelo menos, uma vez por ano ou dentro do período de programação de manutenção prescrita, dependendo do tipo de instalação.

- GB If SIMES S.p.A. agrees to receive back some fittings for laboratory testing, they MUST NOT BE DISASSEMBLED. If necessary remove only the upper ring, to remove the fitting from its recessing box. The connection box, where the wiring to the terminal block is done, must not be opened and you must cut the cable around 10-20 cm from the connection box.
- I Nel caso in cui SIMES S.p.A. dia il consenso al reso di apparecchi per il controllo, essi dovranno essere resi senza essere smontati (aprire solo l'anello superiore per la rimozione dalla cassaforma, ove necessario). La scatola di cablaggio NON DEVE essere aperta; il pressacavo non deve essere toccato; deve essere lasciato un pezzo di cavo di alimentazione di 10-20 cm. uscente dalla scatola di cablaggio.
- D Wenn SIMES S.p.A. der Rücksendung von Leuchten zwecks Prüfung zustimmt, diese bitte vorher nicht zerlegen. Wenn nötig, nur den oberen Ring entfernen, um die Leuchte aus dem Einbaugeschäube zu nehmen. Nicht den Anschlusskasten und die Verschraubung öffnen, das Kabel in 10-20 cm Abstand von der Anschlussdose durchtrennen.
- F Dans le cas où SIMES S.p.a donne son accord pour un retour d'appareils afin d'en effectuer le contrôle, ceux-ci devront être rendus sans être démontés (ouvrir uniquement la collerette supérieure pour le désolidariser du boîtier d'encastrement, si nécessaire). La boîte de câblage ne DOIT PAS être ouverte, le presse-étoupe ne doit pas être touché ; il faut laisser, à la sortie de la boîte de câblage, un morceau de câble d'alimentation de 10 à 20 cm.
- E En el caso que SIMES S.p.A. deba analizar algún aparato , deberá entregarse sólo el aro superior. La caja de cableado NO DEBE ABRIRSE; el prensa no debe tocarse y debe dejarse un cable de 10-20cm saliendo de la caja de cableado.

- GB Use only flexible cables of suitable diameter according to the national installation standards. DO NOT USE HARD CABLES OR ARMOURED CABLES. Use only supply cables with double case. Do not enter with single cables.
- I Utilizzare esclusivamente cavi flessibili di diametro adatto in conformità alle norme di installazione nazionali. NON USARE CAVI RIGIDI e/o CON ANIMA METALLICA. Utilizzare esclusivamente cavi di alimentazione in doppia guaina. Non entrare con fili singoli.
- D Nur flexible Kabel verwenden gemäß den landesspezifischen Installations-standards.. KEINE STARREN LEITUNGEN VERWENDEN. Brauchen Sie nur die Speisekabel mit doppeltem Mantel. Nicht mit einzelnen Kabeln geben.
- F Utiliser uniquement des câbles souples selon les normes nationales d'installation. NE PAS UTILISER DE CABLES RIGIDES ou ARMES. Ne pas entrer avec les fils séparés.
- E Utilizar solo cables flexibles con diámetro adecuado de acuerdo con las normas de instalación nacional. NO ENTRAR CON CABLES RIGIDOS o BLINDADOS. Utilice sólo los cables de alimentación con doble funda. No vayas con cables individuales.
- SE Använd endast kablar med avsedd diameter enligt den nationella installation standard. ANVÄND EJ HÅRDA ELLER ARMERADE KABLAR. Använd endast nätsladdar med dubbel mantel. Gå inte med enstaka trådar.
- NL Gebruik enkel soepele kabels volgens de nationale installatie-norm. GEEN VASTE OF GEWAPENDE SNOEREN GEBRUIKEN ! Gebruik uitsluitend netsnoeren met dubbel omhulsel. Ga niet met enkele draden.
- RU Используйте только гибкие кабели подходящего диаметра в соответствии с национальными стандартами установки. НЕ ИСПОЛЬЗУЙТЕ ЖЕСТКИЕ КАБЕЛИ ИЛИ ЗАПРЕЩЕННЫЕ КАБЕЛИ. Используйте только кабели питания с двойным корпусом. Не вводите с помощью одиночных кабелей.
- FI Käytä vain valaisimelle soveltuvalta ulkohalkaisijalla olevaa kumikaapelia tai vastaavaa asennusstandardin mukaista taipuisaa kaapelia. ÄLÄ KÄYTÄ JÄYKKÄÄ TAI ARMEERATTUA KAAPELIA. Kaapelin johtimet tulee olla suojattu pehmeällä, taipuisalla ulkovaipalla.
- P Utilizar sempre cabos flexíveis de diâmetro adequado de acordo com as normas nacionais de instalação. NUNCA UTILIZAR CABOS RÍGIDOS OU ARMADOS. Utilize apenas os cabos de alimentação com bainha dupla. Não vá com fios individuais.



- GB Before starting any installation or maintenance work, please disconnect the power supply from the device. Ensure that it cannot be re-connected inadvertently!
The power box is suitable for outdoor & indoor use.
Keep proper ventilation around the unit and do not stack any object on it.
- I Prima di procedere con l'installazione o manutenzione, scollegare l'alimentazione dal dispositivo. Assicurarsi che non possa essere ricollegato inavvertitamente!
Il box di alimentazione è adatto per uso esterno ed interno.
Mantenere un'adeguata ventilazione attorno all'unità di alimentazione e non incollare e/o fissare alcun oggetto su di essa.
- D Bevor Sie mit der Installation oder Wartung fortfahren, trennen Sie die Leistung vom Gerät. Vergewissern Sie sich, dass es nicht versehentlich wieder angeschlossen werden kann!
Der Netzteil ist für die Außennutzung des Innenraums geeignet.
Halten Sie eine ausreichende Belüftung rund um das Aggregat und kleben Sie und/oder fixieren Sie keine Gegenstände darauf.
- F Avant de procéder à l'installation ou à l'entretien, débranchez l'appareil. Assurez-vous qu'il ne peut pas être reconnecté par inadvertance!
La boîte de puissance convient à l'usage extérieur de l'intérieur.
Maintenir une ventilation adéquate autour de l'unité d'alimentation et ne pas coller et/ou fixer des objets sur elle.
- E Antes de proceder con la instalación o el mantenimiento, desconecte la alimentación del aparato. ¡ Asegúrese de que no se pueda volver a conectar inadvertidamente!
La caja de la energía es conveniente para el uso exterior del interior.
Mantenga una ventilación adecuada alrededor de la unidad de potencia y no pegue ni fije ningún objeto sobre él.



S.3415

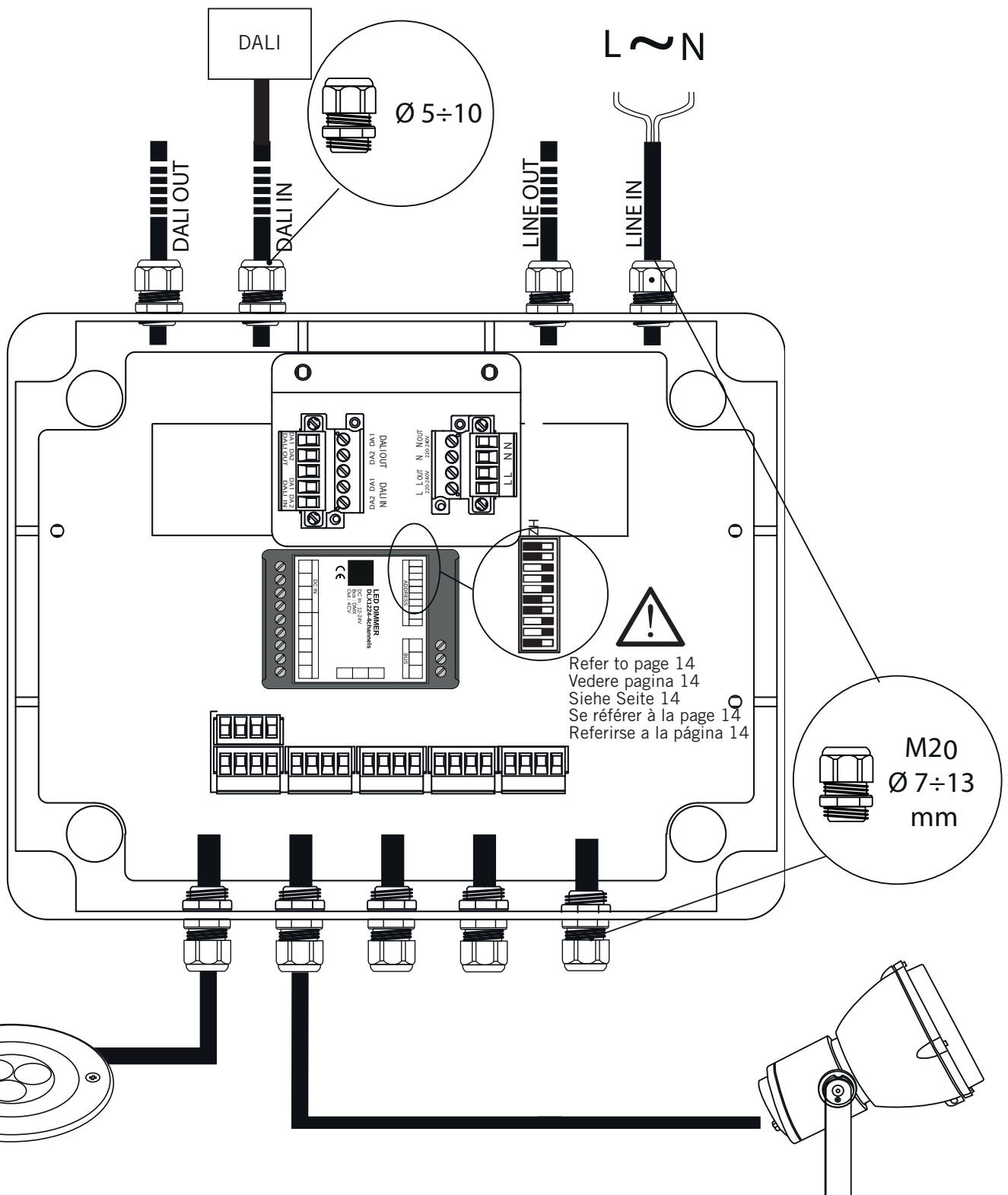

- GB FOR WIRING, PLEASE REFER TO MOUNTING INSTRUCTION OF THE LUMINAIRE
- I PER CABLAGGIO, FARE RIFERIMENTO ALLE ISTRUZIONI DELL'APPARECCHIO
- D FÜR DIE VERDRAHTUNG BEACHTEN SIE BITTE DIE MONTAGEANLEITUNG DER LEUCHE
- F POUR LE CABLAGE, SE DOIT REPORTER A L'INSTRUCTION DE MONTAGE DE L'APPAREIL
- E PARA CABLEADO, CONSULTE LAS INSTRUCCIONES DEL APARATO



- + Nero / Black / Schwarz / Noir / Negro
- R Rosso / Red / Rot / Rouge / Rojo
- G Verde / Green / Grün / Grün / Verde
- B Blu / Blue / Blau / Bleu / Azul
- W White / Bianco / Weiß / Blanc / Blanco



S.3416

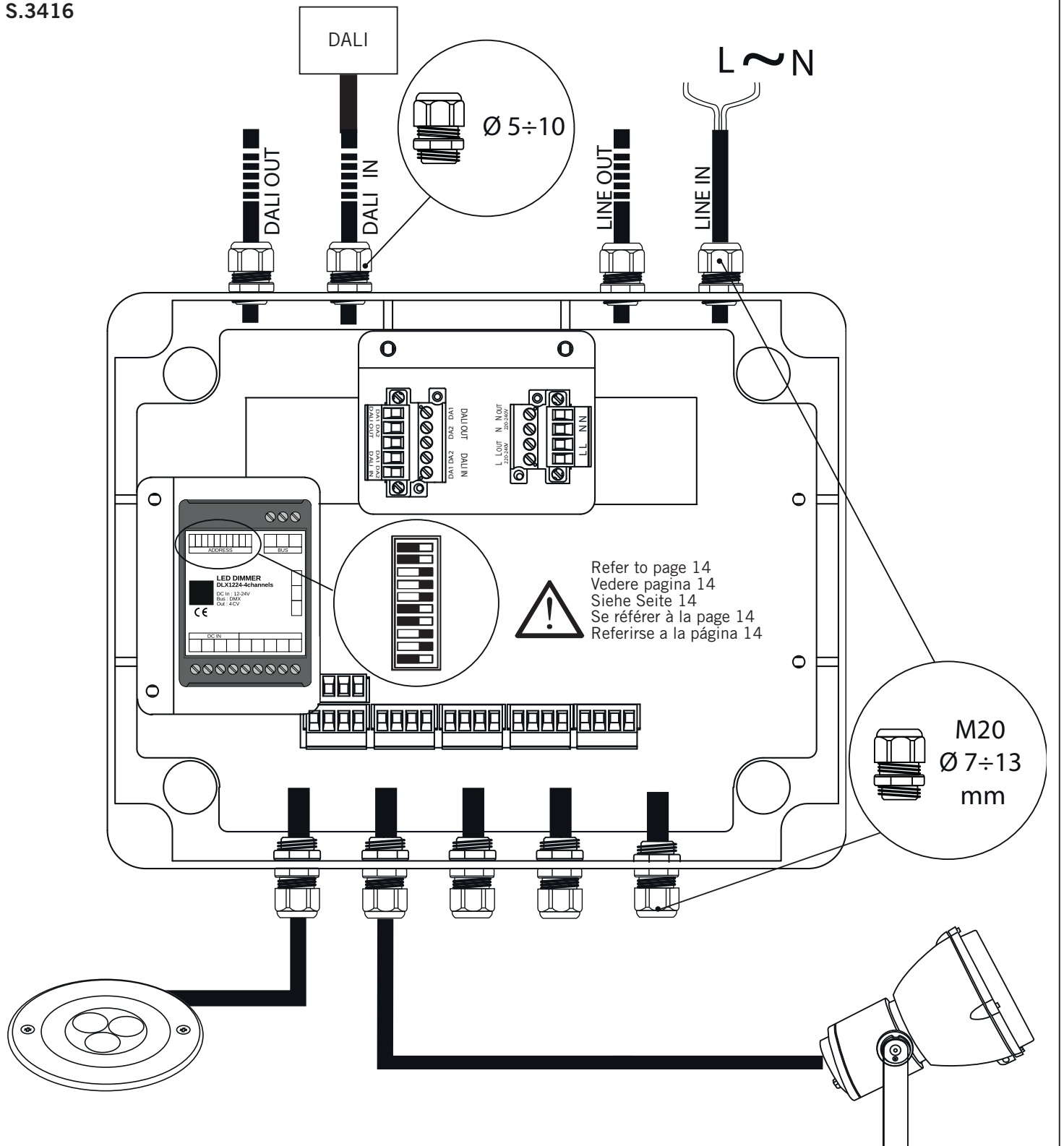

- GB FOR WIRING, PLEASE REFER TO MOUNTING INSTRUCTION OF THE LUMINAIRE
- I PER CABLAGGIO, FARE RIFERIMENTO ALLE ISTRUZIONI DELL'APPARECCHIO
- D FÜR DIE VERDRÄHTUNG BEACHTEN SIE BITTE DIE MONTAGEANLEITUNG DER LEUCHTE
- F POUR LE CABLAGE, SE DOIT REPORTER A L'INSTRUCTION DE MONTAGE DE L'APPAREIL
- E PARA CABLEADO, CONSULTE LAS INSTRUCCIONES DEL APARATO



- + Nero / Black / Schwarz / Noir / Negro
- R Rosso / Red / Rot / Rouge / Rojo
- G Verde / Green / Grün / Grün / Verde
- B Blu / Blue / Blau / Bleu / Azul
- W White / Bianco / Weiß / Blanc / Blanco

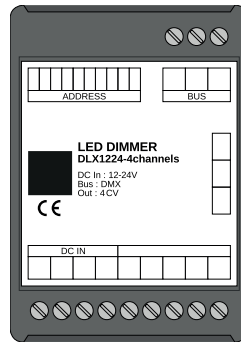

<p>DMX module features:</p> <p>BUS+SEQUENCER+FADER+DIMMER DC input: 12-24Vdc BUS command: DALI Control: RGB or RGBW Typical efficiency: >95% Adjusting the brightness up to complete switch off Soft start and soft stop Optimized output curve Extended temperature range</p>	<p>Electrical characteristics:</p> <p>Max. power per channel: 15W (S.3411) / 22,5W (S.3413) Dimming frequency: D-PWM: 250Hz D-PWM resolution: 16bit D-PWM range: 0,1 - 100% Ambient temperature: Min. -10°C ÷ max +40°C Over voltage protection Under voltage protection Reverse polarity protection Internal circuit input fuse protection</p>
<p>Caratteristiche modulo DMX:</p> <p>BUS+SEQUENCER+FADER+DIMMER Ingresso: DC 12-24Vdc Comando DALI Controllo: colore RGB o RGBW Efficienza tipica: >95% Regolazione della luminosità fino allo spegnimento completo Accensione e spegnimento morbidi Curva di regolazione ottimizzata Range di temperatura esteso</p>	<p>Caratteristiche Elettriche:</p> <p>Potenza massima per canale: 15W (S.3411) / 22,5W (S.3413) Frequenza dimmer: D-PWM: 250Hz Risoluzione D-PWM: 16bit Range D-PWM: 0,1 - 100% Temperatura ambiente: Min. -10°C ÷ max +40°C Protezione da sovralimentazione Protezione da sottoalimentazione Protezione da inversione della polarità Protezione circuito interno con fusibile di ingresso</p>
<p>DMX moduleigenschaften:</p> <p>BUS+SEQUENCER+FADER+DIMMER DC-Eingang: 12-24 VDC BUS Befehl: DALI Steuerung RGB oder RGBW Typische Effizienz:>95% Helligkeitsanpassung bis vollständiges Herunterfahren Sanftanlauf und Sanftanschlag Optimierte Leistungskurve Erweiterter Temperaturbereich</p>	<p>Elektrische Eigenschaften:</p> <p>Max. Leistung pro Kanal: 15W (S.3411) / 22,5W (S.3413) Dimmfrequenz: D-PWM: 250Hz D-PWM-Auflösung: 16bit D-PWM-Bereich: 0,1 - 100% Umgebungstemperatur: Min. -10°C ÷ max +40°C Überspannungsschutz Under voltage protection Verpolungsschutz Interne Sicherungseingangssicherung</p>
<p>Caractéristiques du module DMX:</p> <p>BUS+SEQUENCER+FADER+DIMMER Entrée: DC 12-24Vdc Commande BUS: DALI Control: RGB ou RGBW Efficacité typique:>95% Réglage de la luminosité jusqu'à arrêt complet Doux sur et en dehors Courbe d'ajustement optimisée Plage de température étendue</p>	<p>Caractéristiques électriques:</p> <p>Puissance maximale par canal: 15W (S.3411) / 22,5W (S.3413) Variateur de fréquence: D-PWM: 250Hz Résolution D-PWM: 16bit D-PWM plage: 0,1 - 100% Température ambiante: Min. -10°C ÷ max +40°C Protection de suralimentation Protection contre la sous-alimentation Protection contre l'inversion de polarité Protection du circuit interne avec fusible d'entrée</p>
<p>Características del módulo DMX:</p> <p>BUS+SEQUENCER+FADER+DIMMER Entrada: DC 12-24Vdc Comando BUS: DALI Control: RGB o RGBW Eficiencia típica: >95% Ajuste de brillo hasta cierre completo Suave encendido y apagado Curva de ajuste optimizada Rango de temperatura extendido</p>	<p>Características eléctricas:</p> <p>Potencia máxima por canal: 15W (S.3411) / 22,5W (S.3413) Frecuencia de atenuación: D-PWM: 250Hz Resolución D-PWM: 16bit Rango D-PWM: 0,1 - 100% Temperatura ambiente: Min. -10°C ÷ max +40°C Protección de exceso de suministro Protección contra la desnutrición. Protección contra polaridad inversa Protección del circuito interno con fusible de entrada</p>



DIP SWITCH SETTINGS (Factory setting: 1,2,3,4,5,6,7,8,9,10 = OFF)
IMPOSTAZIONI DIP SWITCH (Impostazioni di fabbrica: 1,2,3,4,5,6,7,8,9,10 = OFF)
DIP-SCHALTER-EINSTELLUNGEN (Werkseinstellung: 1,2,3,4,5,6,7,8,9,10 = OFF)
RÉGLAGES DIP SWITCH (Réglages d'usine: 1,2,3,4,5,6,7,8,9,10 = OFF)
AJUSTES DE INTERRUPTOR DIP (Ajustes de fábrica: 1,2,3,4,5,6,7,8,9,10 = OFF)

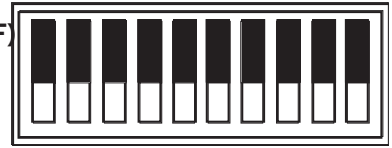

STAND ALONE SETTINGS / IMPOSTAZIONI INDIPENDENTE

FUNCTION	DIP-SWITCH																																																																																																																					
64 static colours 64 colori statici 64 statische Farben 64 couleurs statiques 64 colores estáticos	 <table border="1"> <tr> <td>Red</td> <td>Green</td> <td>Blue</td> <td>White</td> <td>off</td> <td>on</td> </tr> </table>	Red	Green	Blue	White	off	on	<p>DIP 9 = OFF DIP 10 = ON</p> <table border="1"> <thead> <tr> <th></th> <th colspan="2">RED</th> <th colspan="2">GREEN</th> <th colspan="2">BLUE</th> <th colspan="2">WHITE</th> </tr> <tr> <th>LEVELS</th> <th colspan="2">1st CHANNEL</th> <th colspan="2">2nd CHANNEL</th> <th colspan="2">3rd CHANNEL</th> <th colspan="2">4th CHANNEL</th> </tr> <tr> <th></th> <th>DIP 1</th> <th>DIP 2</th> <th>DIP 3</th> <th>DIP 4</th> <th>DIP 5</th> <th>DIP 6</th> <th>DIP 7</th> <th>DIP 8</th> </tr> </thead> <tbody> <tr> <td>100%</td> <td>ON</td> <td>ON</td> <td>ON</td> <td>ON</td> <td>ON</td> <td>ON</td> <td>ON</td> <td>ON</td> </tr> <tr> <td>66%</td> <td>OFF</td> <td>ON</td> <td>OFF</td> <td>ON</td> <td>OFF</td> <td>ON</td> <td>OFF</td> <td>ON</td> </tr> <tr> <td>33%</td> <td>ON</td> <td>OFF</td> <td>ON</td> <td>OFF</td> <td>ON</td> <td>OFF</td> <td>ON</td> <td>OFF</td> </tr> <tr> <td>0%</td> <td>OFF</td> <td>OFF</td> <td>OFF</td> <td>OFF</td> <td>OFF</td> <td>OFF</td> <td>OFF</td> <td>OFF</td> </tr> </tbody> </table>		RED		GREEN		BLUE		WHITE		LEVELS	1 st CHANNEL		2 nd CHANNEL		3 rd CHANNEL		4 th CHANNEL			DIP 1	DIP 2	DIP 3	DIP 4	DIP 5	DIP 6	DIP 7	DIP 8	100%	ON	ON	ON	ON	ON	ON	ON	ON	66%	OFF	ON	OFF	ON	OFF	ON	OFF	ON	33%	ON	OFF	ON	OFF	ON	OFF	ON	OFF	0%	OFF	OFF	OFF	OFF	OFF	OFF	OFF	OFF																																															
Red	Green	Blue	White	off	on																																																																																																																	
	RED		GREEN		BLUE		WHITE																																																																																																															
LEVELS	1 st CHANNEL		2 nd CHANNEL		3 rd CHANNEL		4 th CHANNEL																																																																																																															
	DIP 1	DIP 2	DIP 3	DIP 4	DIP 5	DIP 6	DIP 7	DIP 8																																																																																																														
100%	ON	ON	ON	ON	ON	ON	ON	ON																																																																																																														
66%	OFF	ON	OFF	ON	OFF	ON	OFF	ON																																																																																																														
33%	ON	OFF	ON	OFF	ON	OFF	ON	OFF																																																																																																														
0%	OFF	OFF	OFF	OFF	OFF	OFF	OFF	OFF																																																																																																														
Rainbow Arcobaleno Regenbogen arc en ciel Arco iris	 <table border="1"> <tr> <td>colors level</td> <td>white level</td> <td>rainbow time</td> <td>off</td> <td>on</td> <td>on</td> </tr> </table>	colors level	white level	rainbow time	off	on	on	<p>DIP 8 = OFF DIP 9 = ON DIP 10 = ON</p> <table border="1"> <thead> <tr> <th></th> <th colspan="2">DIP 1</th> <th colspan="2">DIP 2</th> <th colspan="2">DIP 3</th> <th colspan="2">DIP 4</th> </tr> </thead> <tbody> <tr> <td>100%</td> <td>ON</td> <td></td> <td>ON</td> <td></td> <td>ON</td> <td></td> <td>ON</td> <td></td> </tr> <tr> <td>66%</td> <td>OFF</td> <td></td> <td>ON</td> <td></td> <td>OFF</td> <td></td> <td>ON</td> <td></td> </tr> <tr> <td>33%</td> <td>ON</td> <td></td> <td>OFF</td> <td></td> <td>ON</td> <td></td> <td>OFF</td> <td></td> </tr> <tr> <td>0%</td> <td>OFF</td> <td></td> <td>OFF</td> <td></td> <td>OFF</td> <td></td> <td>OFF</td> <td></td> </tr> </tbody> </table> <table border="1"> <thead> <tr> <th>TIME</th> <th colspan="2">DIP 5</th> <th colspan="2">DIP 6</th> <th colspan="2">DIP 7</th> </tr> </thead> <tbody> <tr> <td>30 min.</td> <td>-----ON-----</td> <td></td> <td>-----ON-----</td> <td></td> <td>-----ON-----</td> <td></td> </tr> <tr> <td>15 min.</td> <td>-----OFF-----</td> <td></td> <td>-----ON-----</td> <td></td> <td>-----ON-----</td> <td></td> </tr> <tr> <td>6 min.</td> <td>-----ON-----</td> <td></td> <td>-----OFF-----</td> <td></td> <td>-----ON-----</td> <td></td> </tr> <tr> <td>1 min.</td> <td>---OFF---</td> <td></td> <td>---OFF---</td> <td></td> <td>---ON---</td> <td></td> </tr> <tr> <td>30 sec.</td> <td>--ON--</td> <td></td> <td>--ON--</td> <td></td> <td>--OFF--</td> <td></td> </tr> <tr> <td>15 sec.</td> <td>-OFF-</td> <td></td> <td>-ON-</td> <td></td> <td>-OFF-</td> <td></td> </tr> <tr> <td>6 sec.</td> <td>-ON-</td> <td></td> <td>-OFF-</td> <td></td> <td>-OFF-</td> <td></td> </tr> <tr> <td>3 sec.</td> <td>OFF</td> <td></td> <td>OFF</td> <td></td> <td>OFF</td> <td></td> </tr> </tbody> </table>		DIP 1		DIP 2		DIP 3		DIP 4		100%	ON		ON		ON		ON		66%	OFF		ON		OFF		ON		33%	ON		OFF		ON		OFF		0%	OFF		OFF		OFF		OFF		TIME	DIP 5		DIP 6		DIP 7		30 min.	-----ON-----		-----ON-----		-----ON-----		15 min.	-----OFF-----		-----ON-----		-----ON-----		6 min.	-----ON-----		-----OFF-----		-----ON-----		1 min.	---OFF---		---OFF---		---ON---		30 sec.	--ON--		--ON--		--OFF--		15 sec.	-OFF-		-ON-		-OFF-		6 sec.	-ON-		-OFF-		-OFF-		3 sec.	OFF		OFF		OFF			
colors level	white level	rainbow time	off	on	on																																																																																																																	
	DIP 1		DIP 2		DIP 3		DIP 4																																																																																																															
100%	ON		ON		ON		ON																																																																																																															
66%	OFF		ON		OFF		ON																																																																																																															
33%	ON		OFF		ON		OFF																																																																																																															
0%	OFF		OFF		OFF		OFF																																																																																																															
TIME	DIP 5		DIP 6		DIP 7																																																																																																																	
30 min.	-----ON-----		-----ON-----		-----ON-----																																																																																																																	
15 min.	-----OFF-----		-----ON-----		-----ON-----																																																																																																																	
6 min.	-----ON-----		-----OFF-----		-----ON-----																																																																																																																	
1 min.	---OFF---		---OFF---		---ON---																																																																																																																	
30 sec.	--ON--		--ON--		--OFF--																																																																																																																	
15 sec.	-OFF-		-ON-		-OFF-																																																																																																																	
6 sec.	-ON-		-OFF-		-OFF-																																																																																																																	
3 sec.	OFF		OFF		OFF																																																																																																																	
Strobo	 <table border="1"> <tr> <td>R</td> <td>G</td> <td>B</td> <td>W</td> <td>strobo rate</td> <td>on</td> <td>on</td> <td>on</td> </tr> </table>	R	G	B	W	strobo rate	on	on	on	<p>DIP 8 = ON DIP 9 = ON DIP 10 = ON</p> <table border="1"> <thead> <tr> <th></th> <th colspan="2">RED</th> <th colspan="2">GREEN</th> <th colspan="2">BLUE</th> <th colspan="2">WHITE</th> </tr> <tr> <th>LEVEL</th> <th colspan="2">1st CHANNEL</th> <th colspan="2">2nd CHANNEL</th> <th colspan="2">3rd CHANNEL</th> <th colspan="2">4th CHANNEL</th> </tr> <tr> <th></th> <th colspan="2">DIP 1</th> <th colspan="2">DIP 2</th> <th colspan="2">DIP 3</th> <th colspan="2">DIP 4</th> </tr> </thead> <tbody> <tr> <td></td> <td colspan="2">ON</td> <td colspan="2">ON</td> <td colspan="2">ON</td> <td colspan="2">ON</td> </tr> <tr> <td></td> <td colspan="2">OFF</td> <td colspan="2">OFF</td> <td colspan="2">OFF</td> <td colspan="2">OFF</td> </tr> </tbody> </table> <table border="1"> <thead> <tr> <th>fps</th> <th colspan="2">DIP 5</th> <th colspan="2">DIP 6</th> <th colspan="2">DIP 7</th> </tr> </thead> <tbody> <tr> <td>10</td> <td colspan="2">ON</td> <td colspan="2">ON</td> <td colspan="2">ON</td> </tr> <tr> <td>8</td> <td colspan="2">OFF</td> <td colspan="2">ON</td> <td colspan="2">ON</td> </tr> <tr> <td>6</td> <td colspan="2">ON</td> <td colspan="2">OFF</td> <td colspan="2">ON</td> </tr> <tr> <td>5</td> <td colspan="2">OFF</td> <td colspan="2">OFF</td> <td colspan="2">ON</td> </tr> <tr> <td>4</td> <td colspan="2">ON</td> <td colspan="2">ON</td> <td colspan="2">OFF</td> </tr> <tr> <td>3</td> <td colspan="2">OFF</td> <td colspan="2">ON</td> <td colspan="2">OFF</td> </tr> <tr> <td>2</td> <td colspan="2">ON</td> <td colspan="2">OFF</td> <td colspan="2">OFF</td> </tr> <tr> <td>1</td> <td colspan="2">OFF</td> <td colspan="2">OFF</td> <td colspan="2">OFF</td> </tr> </tbody> </table>		RED		GREEN		BLUE		WHITE		LEVEL	1 st CHANNEL		2 nd CHANNEL		3 rd CHANNEL		4 th CHANNEL			DIP 1		DIP 2		DIP 3		DIP 4			ON		ON		ON		ON			OFF		OFF		OFF		OFF		fps	DIP 5		DIP 6		DIP 7		10	ON		ON		ON		8	OFF		ON		ON		6	ON		OFF		ON		5	OFF		OFF		ON		4	ON		ON		OFF		3	OFF		ON		OFF		2	ON		OFF		OFF		1	OFF		OFF		OFF	
R	G	B	W	strobo rate	on	on	on																																																																																																															
	RED		GREEN		BLUE		WHITE																																																																																																															
LEVEL	1 st CHANNEL		2 nd CHANNEL		3 rd CHANNEL		4 th CHANNEL																																																																																																															
	DIP 1		DIP 2		DIP 3		DIP 4																																																																																																															
	ON		ON		ON		ON																																																																																																															
	OFF		OFF		OFF		OFF																																																																																																															
fps	DIP 5		DIP 6		DIP 7																																																																																																																	
10	ON		ON		ON																																																																																																																	
8	OFF		ON		ON																																																																																																																	
6	ON		OFF		ON																																																																																																																	
5	OFF		OFF		ON																																																																																																																	
4	ON		ON		OFF																																																																																																																	
3	OFF		ON		OFF																																																																																																																	
2	ON		OFF		OFF																																																																																																																	
1	OFF		OFF		OFF																																																																																																																	



BUS DALI SETTINGS / IMPOSTAZIONI BUS DALI

Function	DIP-SWITCH																					
DALI Random Address Allocation		Addressing managed by DALI BUS. All DIPS are OFF.																				
		<table border="1"> <thead> <tr> <th>DIP 1</th><th>DIP 2</th><th>DIP 3</th><th>DIP 4</th><th>DIP 5</th><th>DIP 6</th><th>DIP 7</th><th>DIP 8</th><th>DIP 9</th><th>DIP 10</th> </tr> </thead> <tbody> <tr> <td>OFF</td><td>OFF</td><td>OFF</td><td>OFF</td><td>OFF</td><td>OFF</td><td>OFF</td><td>OFF</td><td>OFF</td><td>OFF</td> </tr> </tbody> </table>	DIP 1	DIP 2	DIP 3	DIP 4	DIP 5	DIP 6	DIP 7	DIP 8	DIP 9	DIP 10	OFF	OFF	OFF	OFF	OFF	OFF	OFF	OFF	OFF	OFF
	DIP 1	DIP 2	DIP 3	DIP 4	DIP 5	DIP 6	DIP 7	DIP 8	DIP 9	DIP 10												
OFF	OFF	OFF	OFF	OFF	OFF	OFF	OFF	OFF	OFF													
Manual addressing [0..63]		Manual Addressing.																				
		DIP 10 = OFF																				
		Address DALI from 0 to 63 = (1*dip1 + 2*dip2 + 4*dip3 + ... + 64*dip7) -1 See the following table to set the address. In the table: - value 1 corresponds to dip ON - value 0 corresponds to dip OFF																				

addr	dip-switch	addr	dip-switch	addr	dip-switch	addr	dip-switch	addr	dip-switch	addr	dip-switch	addr	dip-switch	addr	dip-switch
123456789	123456789	123456789	123456789	123456789	123456789	123456789	123456789	123456789	123456789	123456789	123456789	123456789	123456789	123456789	123456789
by DALI	000000000														
0	100000000	8	100100000	16	100010000	24	100110000	32	100001000	40	100101000	48	100011000	56	100111000
1	010000000	9	010100000	17	010010000	25	010110000	33	010001000	41	010101000	49	010011000	57	010111000
2	110000000	10	110100000	18	110010000	26	110110000	34	110001000	42	110101000	50	110011000	58	110111000
3	001000000	11	001100000	19	001010000	27	001110000	35	001001000	43	001101000	51	001011000	59	001111000
4	101000000	12	101100000	20	101010000	28	101110000	36	101001000	44	101101000	52	101011000	60	101111000
5	011000000	13	011100000	21	011010000	29	011110000	37	011001000	45	011101000	53	011011000	61	011111000
6	111000000	14	111100000	22	111010000	30	111110000	38	111001000	46	111101000	54	111011000	62	111111000
7	000100000	15	000010000	23	000110000	31	000001000	39	000101000	47	000011000	55	000111000	63	000000100

APPLICATION EXAMPLE: suppose you want to set the address 38 in the device. The following values need to be set on the switches:
 DIP 1 = ON, DIP 2 = ON, DIP 3 = ON, DIP 4 = OFF, DIP 5 = OFF, DIP 6 = ON, DIP 7 = OFF, DIP 8 = OFF, DIP 9 = OFF, DIP 10 = OFF.

Function

Considering the colours configuration depicted in paragraph **Installation** at page 3, the 4 intensities can be controlled by the following addresses:

Addr	Function	Value
+0	R	R 0 .. 254
+1	G	G 0 .. 254
+2	B	B 0 .. 254
+3	W	W 0.. 254

APPLICATION EXAMPLE: suppose you have manually set the address 38 in the device. Then, operating on DALI address:
 - 38 the first output intensity can be managed (red colour);
 - 39 the second output intensity can be managed (green colour);
 - 40 the third output intensity can be managed (blue colour);
 - 41 the fourth output intensity can be managed (white colour).

DEFAULT VALUES

	FACTORY	RESET
ACTUAL LEVEL	254	254
POWER ON LEVEL	254	254
SYSTEM FAILURE LEVEL	254	254
MIN LEVEL	1	1
MAX LEVEL	254	254
FADE RATE	7	7
FADE TIME	0	0
SHORT ADDRESS	FF	(no change)
SEARCH ADDRESS	FF FF FF	FF FF FF
RANDOM ADDRESS	FF FF FF	FF FF FF
GROUP 0-7	0	0
GROUP 8-15	0	0
SCENE 0-15	MASK	MASK
STATUS INFORMATION	1??0????	0?100???
VERSION NUMBER	1	(no change)
PHYSICAL MIN. LEVEL	1	(no change)



Cable cross-section/length - Sezione cavo/lunghezza

DALI constant voltage PSU box - Box tensione costante DALI (24Vdc)

Distance - Distanza (D)	5 mt	10 mt	15 mt	-
Cable section - Sezione cavo	0,75 mm ²	1 mm ²	1,5 mm ²	-

Check the accordance of the final application with the reference norms.
 Verificare che nell'applicazione finale siano rispettate tutte le normative di riferimento.
 Endgültige Referenz mit den Referenznormen.
 Vérifier que toutes les normes de référence sont respectées dans l'application finale.
 Verifique que todos los estándares de referencia sean respetados en la aplicación final.

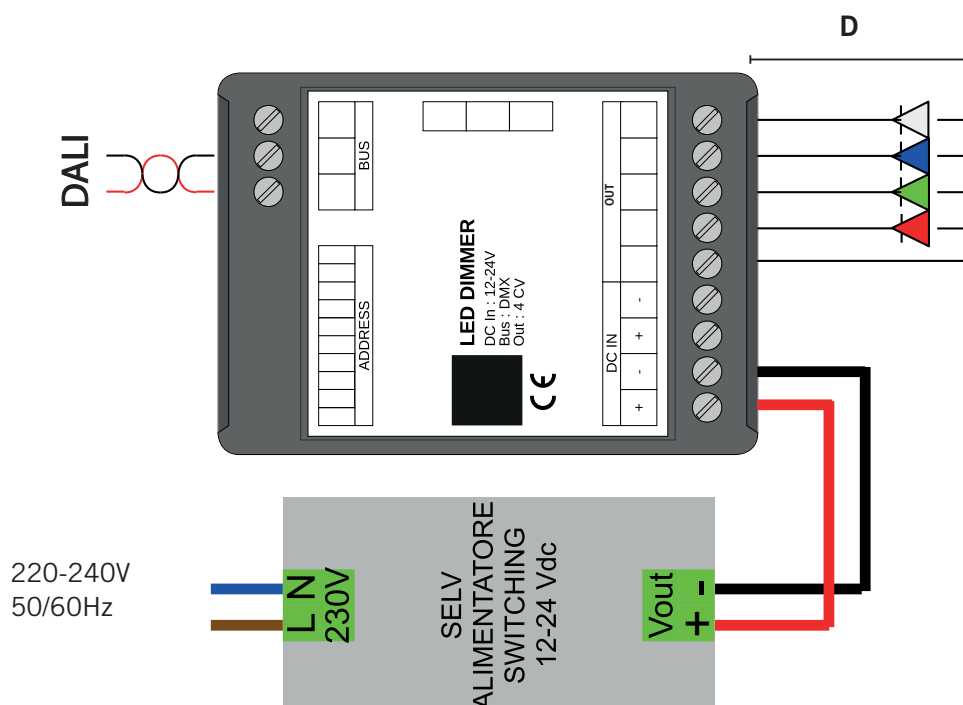

GB SIMES reserves the right to introduce all the technical and structural changes required for the improvement of the product.

I SIMES si riserva di apportare modifiche tecniche e strutturali necessarie al miglioramento del prodotto in qualsiasi momento.

D SIMES behält sich vor jederzeit, die zur Aufbesserung des Produkts notwendigen technischen und strukturellen Änderungen zu bringen.

F SIMES se réserve d'apporter à n'importe quel moment toute modification technique et structurelle qu'on trouve nécessaire pour l'amélioration du produit.

E SIMES se reserva la facultad de aportar las modificaciones técnicas y estructurales necesarias para el mejoramiento del producto en cualquier momento.

**RAEE - WEEE****GB Directive 2002/96/CE (Waste Electrical and Electronic Equipment - WEEE): information for users**

The crossed out wheeled bin label that can be found on your product indicates that this product should not be disposed of via the normal household waste stream. To prevent possible harm to the environment or human health please separate this product from other waste streams to ensure that it can be recycled in an environmentally sound manner. For more details on available collection facilities please contact your local government office or the retailer where you purchased this product.

I DIRETTIVA 2002/96/CE (Rifiuti di Apparecchiature Elettriche ed Elettroniche - RAEE): informazioni agli utenti

L'etichetta con il cassonetto barrato presente sul prodotto indica che il prodotto non deve essere smaltito tramite la procedura normale di smaltimento dei rifiuti domestici. Per evitare eventuali danni all'ambiente e alla salute umana separare questo prodotto da altri rifiuti domestici in modo che possa venire riciclato in base alle procedure di rispetto ambientale. Per maggiori dettagli sui centri di raccolta disponibili, contattare l'ufficio governativo locale o il rivenditore del prodotto.

D Richtlinie 2002/96/EU (Elektro- und Elektronik- Altgeräte - WEEE): Benutzerinformationen

Der Aufkleber mit durchgekreuzter Mülltonne an diesem Produkt weist darauf hin, dass dieses Produkt nicht im normalen Hausmüll entsorgt werden darf. Zur Vermeidung einer möglichen Beeinträchtigung der Umwelt oder der menschlichen Gesundheit darf dieses Produkt nicht in den Hausmüll gegeben werden, um zu gewährleisten, dass es in einer umweltverträglichen Weise recycelt wird. Wenden Sie sich für Informationen zu Entsorgungseinrichtungen an die zuständige Behörde oder das Geschäft, in dem Sie dieses Produkt erworben haben.

F Directive 2002/96/CE (Déchets d'équipements électriques et électroniques - DEEE): informations aux utilisateurs

L'étiquette apposée sur ce produit et représentant une poubelle à roulettes rayée indique que le produit ne peut être mis au rebut avec les déchets domestiques normaux. Afin d'éviter d'éventuels dommages au niveau de l'environnement ou de la vie humaine, veuillez séparer ce produit des autres déchets de manière à garantir qu'il soit recyclé de manière sûre au niveau environnemental. Pour plus de détails sur les sites de collecte existants, veuillez contacter l'administration locale ou le détaillant auprès duquel vous avez acheté ce produit.

E Directiva 2002/96/CE (Residuos de aparatos eléctricos y electrónicos - RAEE): Información para el usuario

La etiqueta de un contenedor tachado que hallará en su producto indica que este producto no se puede tirar con la basura doméstica normal. Para impedir posibles daños medioambientales o para la salud, separe este producto de otros canales de desecho para garantizar que se recicle de una forma segura para el medio ambiente. Para más información sobre las instalaciones de recolección disponibles, diríjase a las autoridades locales o al punto de venta donde adquirió este producto.

SE Directive 2002/96/CE (Waste Electrical and Electronic Equipment - WEEE): information for users

Symbolen med en överkorsad soptunna innebär att denna produkt inte får kastas i vanligt hushållsavfall. För att skydda miljön och hälsan bör denna produkt inte kastas tillsammans med vanligt hushållsavfall utan lämnas för återvinning på tillbörligt sätt. För mer information om uppsamlingsplatser, kontakta en lokal myndighet eller den återförsäljare som du köpte produkten från.

NL Richtlijn 2002/96/EG (Afgedankte Elektrische en Elektronische Apparaten - AEEA): informatie voor de gebruikers

Op uw product is een label van een rolcontainer met een kruis erdoor aangebracht. Dit wil zeggen dat dit product niet bij het normale huishoudelijk afval mag worden gedaan. Om eventuele schade aan het milieu of de gezondheid van de mens te voorkomen moet dit product gescheiden van al het ander afval worden ingezameld, zodat het op een verantwoorde wijze kan worden verwerkt. Voor meer informatie over uw lokale afvalinzameling wendt u zich tot uw gemeente of de leverancier bij wie u dit product hebt gekocht.

PL Dyrektywa 2002/96/CE (WEEE - ang. Waste Electrical and Electronic Equipment): informacja dla użytkowników

Użycie symbolu WEEE oznacza, że niniejszy produkt nie może być traktowany jako odpad domowy. Zapewniając prawidłową utylizację pomagasz chronić środowisko naturalne. W celu uzyskania bardziej szczegółowych informacji dotyczących recyklingu niniejszego produktu należy skontaktować się z przedstawicielem władz lokalnych, dostawcą usług utylizacji odpadów lub sklepem, gdzie nabyto produkt.

FI Directive 2002/96/CE (Waste Electrical and Electronic Equipment - WEEE): information for users

WEEE-merkintä osoittaa, että tätä tuotetta ei voi käsitellä kotitalousjätteen tavoin. Kun huolehdit tämän tuotteen asianmukaisesta hävittämisestä, autat suojelemaan ympäristöä. Lisätietoa tämän tuotteen kierrättämisestä saat paikallisviranomaisilta, jätehuoltoyhtiöltäsi tai myymälästä, josta ostit tämän tuotteen.

PT Directiva 2002/96/CE (Resíduos de equipamentos eléctricos e electrónicos - REEE): informações para os utilizadores

A etiqueta com o símbolo de um contentor de lixo barrado com uma cruz que aparece no produto indica que este produto não deve ser deitado fora juntamente com o lixo doméstico. Para evitar possíveis danos no ambiente ou na saúde pública, por favor separe este produto de outros lixos; desta forma, terá a certeza de que pode ser reciclado através de métodos não prejudiciais ao ambiente. Para obter mais informações sobre os locais de recolha de lixo disponíveis, contacte a sua junta de freguesia ou o local onde comprou este produto.



This information only applies to customers in the European Union, according to Directive 2002/96/EC OF THE EUROPEAN PARLIAMENT AND OF THE COUNCIL OF 27 January 2003 on waste electrical and electronic equipment (WEEE) and legislation transposing and implementing it into the various national legal systems.

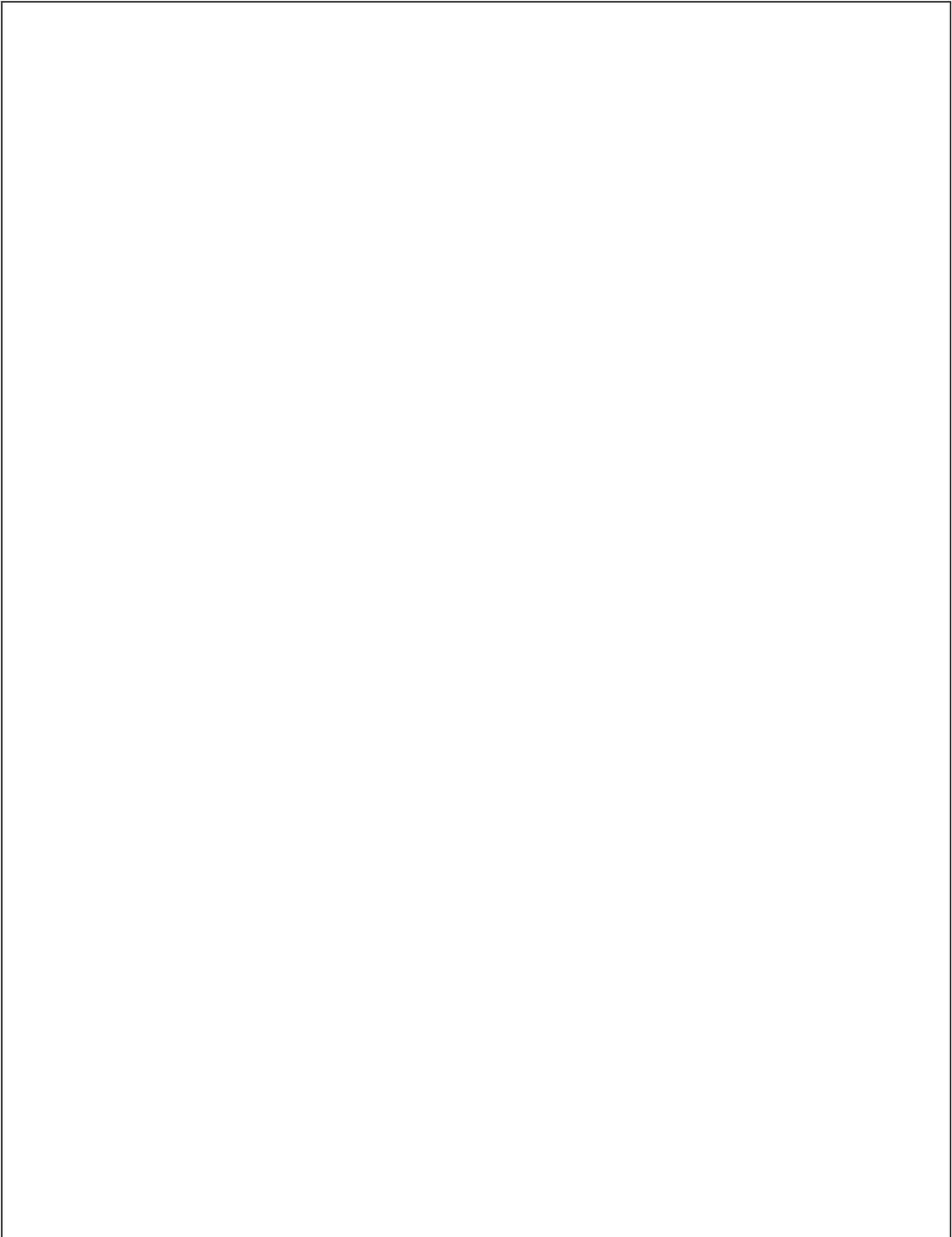

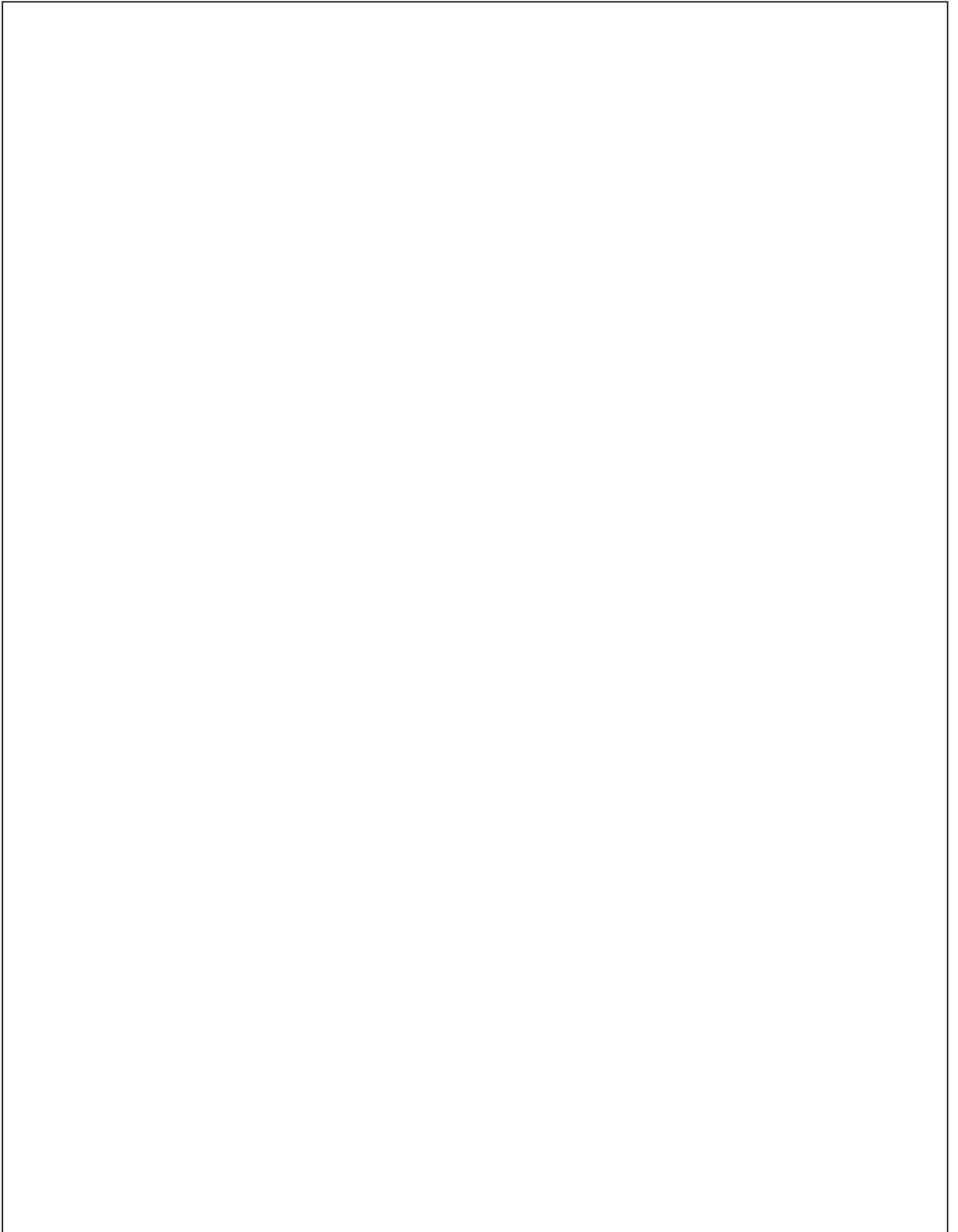

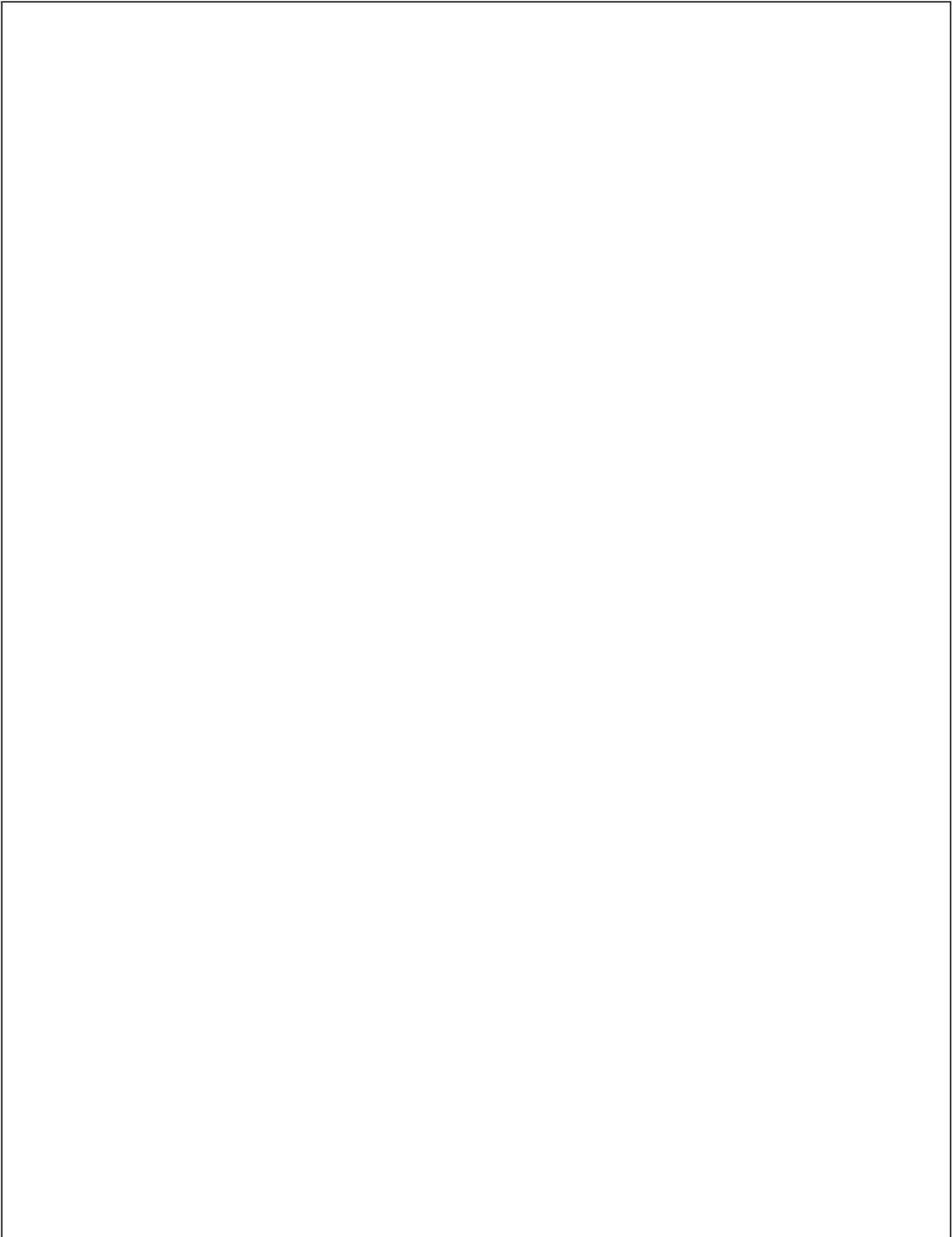

S I M E S

luce per l'architettura

SIMES S.p.A. VIA G. PASTORE 2/4 - 25040 CORTE FRANCA (BS) - ITALY
TEL. +39 0309860430 - FAX +39 0309860439
E-mail: simes@simes.it - <http://www.simes.it>