





Catch incasso

Downlight ottica comfort

Catch è un innovativo downlight che coniuga comfort visivo, ingombri ridotti e possibilità di puntamento tramite il corpo basculante. Il sofisticato sistema ottico focalizza il fascio e rende la luce confortevole riducendo l'abbagliamento diretto della sorgente.

La profondità di incasso estremamente ridotta e la posizione dell'alimentatore posto in prossimità dell'apparecchio, ne facilitano l'installazione a plafone. Catch in versione basculante può essere installato con corpo lampada a filo dell'anello oppure sporgente, per ruotare su angoli ancora più ampi e puntare il fascio in direzioni specifiche.

Catch è disponibile in versione fissa o basculante con anello in alluminio o in acciaio inox per un'estetica ancora più accattivante e per applicazioni particolarmente aggressive.

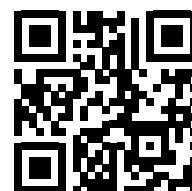

www.simes.it/catch



Casa Y, Pino Torinese, Torino, Italy © Arch. Luca Maria Gandini ph. Mario Bertani

CATCH INCASSO Downlight ottica comfort

Struttura in alluminio pressofuso EN AB-47100 ad elevata resistenza all'ossidazione.
 Anello frontale in alluminio o in acciaio INOX AISI 316L.
 Lenti in policarbonato trasparente.
 Diffusore in vetro temprato di spessore 5 mm.
 Viti in acciaio INOX A4.
 Scatola di alimentazione esterna.
 Apparecchio precablato con cavo 0,4m in neoprene e connettore per connessione remota.
Doppia verniciatura extra resistente.

Finitura CATCH basculante:

- Anello-Corpo Grigio alluminio (cod. 14)
- Anello-Corpo Bianco (cod. 01)
- Anello INOX e corpo basculante nero (cod. 19)

Finitura CATCH fisso:

- Anello-Corpo Grigio alluminio (cod. 14)
- Anello-Corpo Bianco (cod. 01)
- Anello INOX e corpo nero (cod. 19)

Grado di protezione
IP65

Classe di isolamento
CLASSE II 

Resistenza meccanica
IK 08

Versioni led 4000K CRI90 disponibili su richiesta.

CATCH basculante

Catch basculante può essere installato con l'ottica perfettamente a filo dell'anello o con l'ottica sporgente di 15 mm.

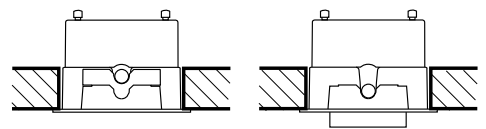

Ottica confortevole

Il sofisticato sistema ottico focalizza il fascio e rende la luce confortevole riducendo l'abbagliamento della sorgente.

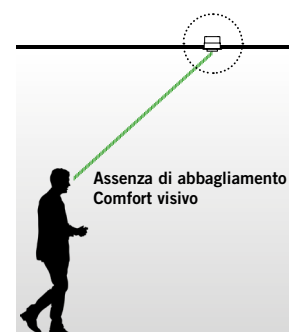

Per dati tecnici aggiornati alle ultime evoluzioni tecnologiche dei led o per ulteriori informazioni tecniche consultare il sito web (www.simes.it).

MODELLO REGISTRATO

Basculante anello alluminio

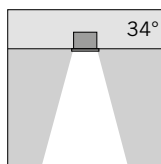
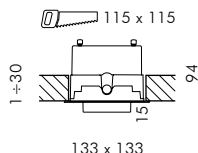

S.7400W

4 HIGH-POWER LED **3000K** CRI90 620lm
 Flusso luminoso apparecchio 448lm
 Potenza totale assorbita 7,6W
 220V-240V AC 50/60Hz / DC Non Dimmerabile
 Ottica basculante $\pm 20^\circ$

h(m)	34°	
	Ø(m)	E(lx)
1	0.60	1254
2	1.21	314
3	1.81	139
4	2.42	78
5	3.02	50

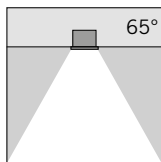

S.7401W

4 HIGH-POWER LED **3000K** CRI90 620lm
 Flusso luminoso apparecchio 415lm
 Potenza totale assorbita 7,6W
 220V-240V AC 50/60Hz / DC Non Dimmerabile
 Ottica basculante $\pm 20^\circ$

h(m)	65°	
	Ø(m)	E(lx)
1	1.27	399
2	2.55	100
3	3.82	44
4	5.10	25
5	6.37	16

**A richiesta versione con fasci:
 7°, 10°x44°**

Basculante anello INOX

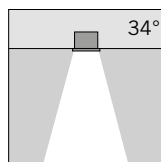
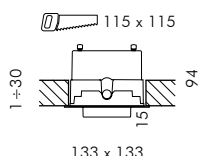

S.7405W.19

4 HIGH-POWER LED **3000K** CRI90 620lm
 Flusso luminoso apparecchio 448lm
 Potenza totale assorbita 7,6W
 220V-240V AC 50/60Hz / DC Non Dimmerabile
 Ottica basculante $\pm 20^\circ$

h(m)	34°	
	Ø(m)	E(lx)
1	0.60	1254
2	1.21	314
3	1.81	139
4	2.42	78
5	3.02	50

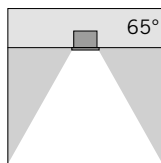

S.7406W.19

4 HIGH-POWER LED **3000K** CRI90 620lm
 Flusso luminoso apparecchio 415lm
 Potenza totale assorbita 7,6W
 220V-240V AC 50/60Hz / DC Non Dimmerabile
 Ottica basculante $\pm 20^\circ$

h(m)	65°	
	Ø(m)	E(lx)
1	1.27	399
2	2.55	100
3	3.82	44
4	5.10	25
5	6.37	16

**A richiesta versione con fasci:
 7°, 10°x44°**

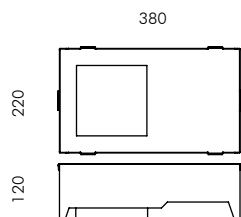

S.7409

CASSAFORMA PER SOFFITTI IN CEMENTO
 per CATCH QUADRATO 4 LED BASCULANTE
 Dim. 220 x 380 x 120mm
 Foro d'incasso 115 x 115mm

CATCH INCASSO QUADRATO 4 LED Fisso

Fisso anello alluminio

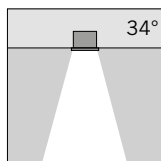
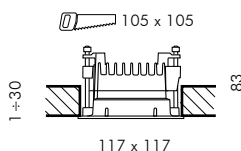
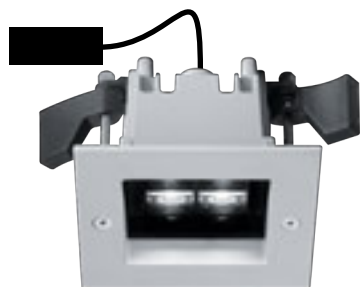

S.7410W

4 HIGH-POWER LED **3000K** CRI90 840lm
 Flusso luminoso apparecchio 582lm
 Potenza totale assorbita 10,3W
 220V-240V AC 50/60Hz / DC Non Dimmerabile
 Ottica fissa

h(m)	34°	
	Ø(m)	E(lx)
1	0.60	1629
2	1.21	407
3	1.81	181
4	2.42	102
5	3.02	65

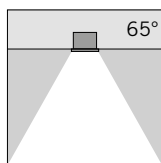

S.7411W

4 HIGH-POWER LED **3000K** CRI90 840lm
 Flusso luminoso apparecchio 589lm
 Potenza totale assorbita 10,3W
 220V-240V AC 50/60Hz / DC Non Dimmerabile
 Ottica fissa

h(m)	65°	
	Ø(m)	E(lx)
1	1.27	566
2	2.55	142
3	3.82	63
4	5.10	35
5	6.37	23

A richiesta versione con fasci:
7°, 10°x44°

Fisso anello INOX

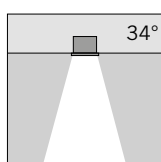
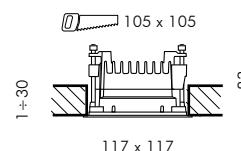
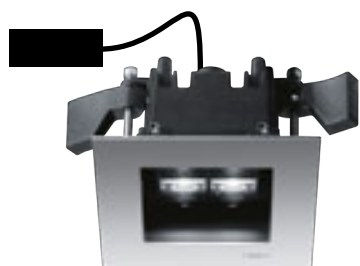

S.7415W.19

4 HIGH-POWER LED **3000K** CRI90 840lm
 Flusso luminoso apparecchio 582lm
 Potenza totale assorbita 10,3W
 220V-240V AC 50/60Hz / DC Non Dimmerabile
 Ottica fissa

h(m)	34°	
	Ø(m)	E(lx)
1	0.60	1629
2	1.21	407
3	1.81	181
4	2.42	102
5	3.02	65

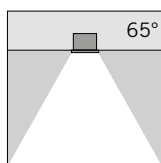

S.7416W.19

4 HIGH-POWER LED **3000K** CRI90 840lm
 Flusso luminoso apparecchio 589lm
 Potenza totale assorbita 10,3W
 220V-240V AC 50/60Hz / DC Non Dimmerabile
 Ottica fissa

h(m)	65°	
	Ø(m)	E(lx)
1	1.27	566
2	2.55	142
3	3.82	63
4	5.10	35
5	6.37	23

A richiesta versione con fasci:
7°, 10°x44°

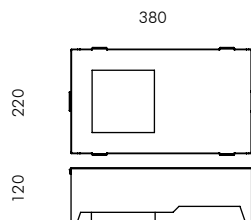

S.7419

CASSAFORMA PER SOFFITTI IN CEMENTO

per CATCH QUADRATO 4 LED FISSO

Dim. 220 x 380 x 120mm

Foro d'incasso 105 x 105mm



CATCH INCASSO QUADRATO 9 LED **Basculante**

Basculante anello alluminio

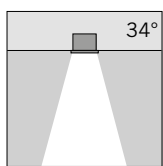
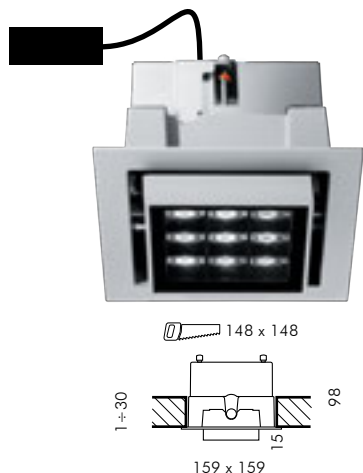

S.7420W

9 HIGH-POWER LED **3000K** CRI90 1390lm
 Flusso luminoso apparecchio 985lm
 Potenza totale assorbita 15W
 220V-240V AC 50/60Hz / DC Non Dimmerabile
 Ottica basculante $\pm 20^\circ$

h(m)	34°	
	Ø(m)	E(lx)
1	0.60	2719
2	1.21	680
3	1.81	302
4	2.42	170
5	3.02	109

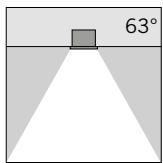

S.7421W

9 HIGH-POWER LED **3000K** CRI90 1390lm
 Flusso luminoso apparecchio 761lm
 Potenza totale assorbita 15W
 220V-240V AC 50/60Hz / DC Non Dimmerabile
 Ottica basculante $\pm 20^\circ$

h(m)	63°	
	Ø(m)	E(lx)
1	1.24	752
2	2.48	188
3	3.72	84
4	4.96	47
5	6.20	30

A richiesta versione con fasci:
7°, 10°x44°

Basculante anello INOX

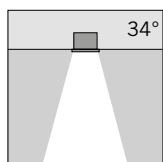
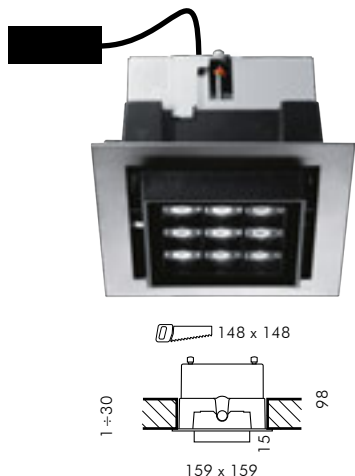

S.7425W.19

9 HIGH-POWER LED **3000K** CRI90 1390lm
 Flusso luminoso apparecchio 985lm
 Potenza totale assorbita 15W
 220V-240V AC 50/60Hz / DC Non Dimmerabile
 Ottica basculante $\pm 20^\circ$

h(m)	34°	
	Ø(m)	E(lx)
1	0.60	2719
2	1.21	680
3	1.81	302
4	2.42	170
5	3.02	109

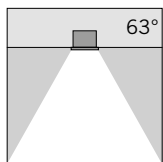

S.7426W.19

9 HIGH-POWER LED **3000K** CRI90 1390lm
 Flusso luminoso apparecchio 761lm
 Potenza totale assorbita 15W
 220V-240V AC 50/60Hz / DC Non Dimmerabile
 Ottica basculante $\pm 20^\circ$

h(m)	63°	
	Ø(m)	E(lx)
1	1.24	752
2	2.48	188
3	3.72	84
4	4.96	47
5	6.20	30

A richiesta versione con fasci:
7°, 10°x44°

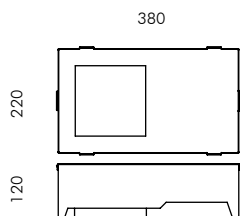

S.7429

CASSAFORMA PER SOFFITTI IN CEMENTO
 per CATCH QUADRATO 9 LED BASCULANTE
 Dim. 220 x 380 x 120mm
 Foro d'incasso 148 x 148mm

Fisso anello alluminio

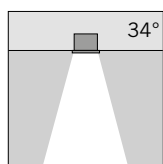
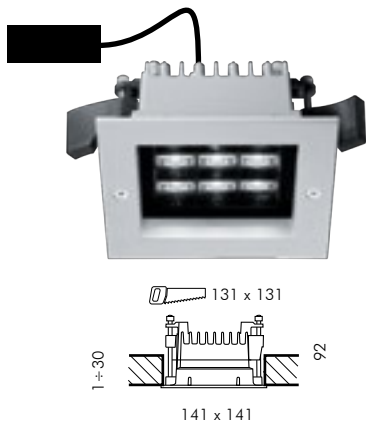

S.7430W

9 HIGH-POWER LED **3000K** CRI90 1890lm
 Flusso luminoso apparecchio 1329lm
 Potenza totale assorbita 20,7W
 220V-240V AC 50/60Hz / DC Non Dimmerabile
 Ottica fissa

h(m)	34°	
	Ø(m)	E(lx)
1	0.60	3644
2	1.21	911
3	1.81	405
4	2.42	228
5	3.02	146

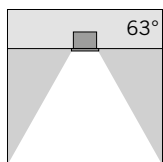

S.7431W

9 HIGH-POWER LED **3000K** CRI90 1890lm
 Flusso luminoso apparecchio 1027lm
 Potenza totale assorbita 20,7W
 220V-240V AC 50/60Hz / DC Non Dimmerabile
 Ottica fissa

h(m)	63°	
	Ø(m)	E(lx)
1	1.24	1009
2	2.48	252
3	3.72	112
4	4.96	63
5	6.20	40

A richiesta versione con fasci:
 7°, 10°x44°

Fisso anello INOX

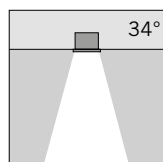
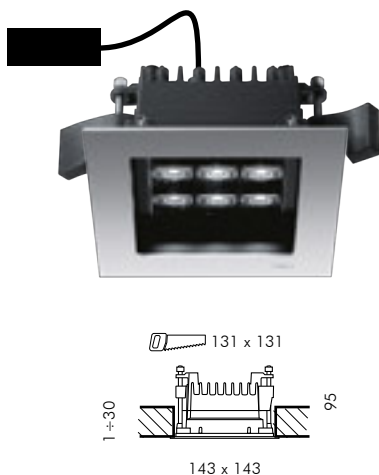

S.7435W.19

9 HIGH-POWER LED **3000K** CRI90 1890lm
 Flusso luminoso apparecchio 1329lm
 Potenza totale assorbita 20,7W
 220V-240V AC 50/60Hz / DC Non Dimmerabile
 Ottica fissa

h(m)	34°	
	Ø(m)	E(lx)
1	0.60	3644
2	1.21	911
3	1.81	405
4	2.42	228
5	3.02	146

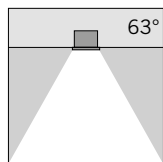

S.7436W.19

9 HIGH-POWER LED **3000K** CRI90 1890lm
 Flusso luminoso apparecchio 1027lm
 Potenza totale assorbita 20,7W
 220V-240V AC 50/60Hz / DC Non Dimmerabile
 Ottica fissa

h(m)	63°	
	Ø(m)	E(lx)
1	1.24	1009
2	2.48	252
3	3.72	112
4	4.96	63
5	6.20	40

A richiesta versione con fasci:
 7°, 10°x44°

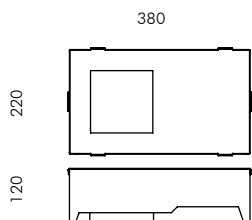

S.7439

CASSAFORMA PER SOFFITTI IN CEMENTO
 per CATCH QUADRATO 9 LED FISSO
 Dim. 220 x 380 x 120mm
 Foro d'incasso 131 x 131mm

CATCH INCASSO RETTANGOLARE 20 LED **Basculante**

Basculante anello alluminio

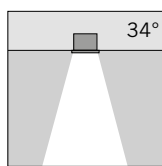
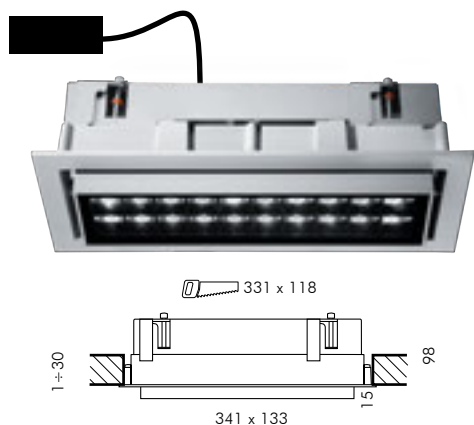

S.7460W

20 HIGH-POWER LED **3000K** CRI90 3140lm
Flusso luminoso apparecchio 2281lm
Potenza totale assorbita 32W
220V-240V AC 50/60Hz / DC Non Dimmerabile
Optica basculante $\pm 20^\circ$

h(m)	34°	
	Ø(m)	E(lx)
1	0.62	6177
2	1.23	1544
3	1.85	686
4	2.46	386
5	3.08	247

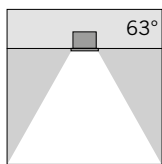

S.7461W

20 HIGH-POWER LED **3000K** CRI90 3140lm
Flusso luminoso apparecchio 1815lm
Potenza totale assorbita 32W
220V-240V AC 50/60Hz / DC Non Dimmerabile
Optica basculante $\pm 20^\circ$

h(m)	63°	
	Ø(m)	E(lx)
1	1.23	1835
2	2.46	459
3	3.69	204
4	4.92	115
5	6.15	73

A richiesta versione con fasci:
7°, 10°x44°

Basculante anello INOX

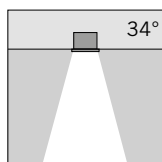
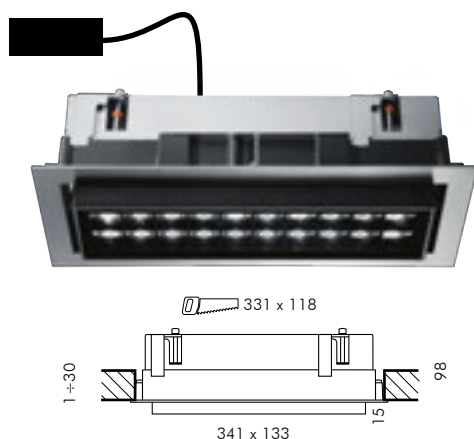

S.7465W.19

20 HIGH-POWER LED **3000K** CRI90 3140lm
Flusso luminoso apparecchio 2281lm
Potenza totale assorbita 32W
220V-240V AC 50/60Hz / DC Non Dimmerabile
Optica basculante $\pm 20^\circ$

h(m)	34°	
	Ø(m)	E(lx)
1	0.62	6177
2	1.23	1544
3	1.85	686
4	2.46	386
5	3.08	247

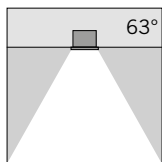

S.7466W.19

20 HIGH-POWER LED **3000K** CRI90 3140lm
Flusso luminoso apparecchio 1815lm
Potenza totale assorbita 32W
220V-240V AC 50/60Hz / DC Non Dimmerabile
Optica basculante $\pm 20^\circ$

h(m)	63°	
	Ø(m)	E(lx)
1	1.23	1835
2	2.46	459
3	3.69	204
4	4.92	115
5	6.15	73

A richiesta versione con fasci:
7°, 10°x44°

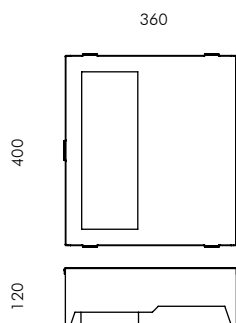

S.7469

CASSAFORMA PER SOFFITTI IN CEMENTO

per CATCH RETTANGOLARE 20 LED BASCULANTE

Dim. 400 x 360 x 120mm

Foro d'incasso 331 x 118mm

CATCH INCASSO RETTANGOLARE 20 LED Fisso

Fisso anello alluminio

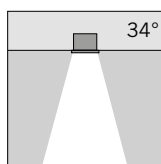
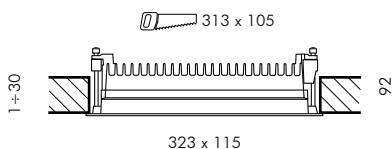

S.7470W □
 20 HIGH-POWER LED **3000K** CRI90 3140lm
 Flusso luminoso apparecchio 2281lm
 Potenza totale assorbita 32W
 220V-240V AC 50/60Hz / DC Non Dimmerabile
 Ottica fissa

h(m)	34°	
	Ø(m)	E(lx)
1	0.62	6177
2	1.23	1544
3	1.85	686
4	2.46	386
5	3.08	247

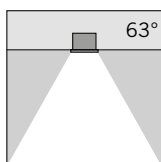

S.7471W □
 20 HIGH-POWER LED **3000K** CRI90 3140lm
 Flusso luminoso apparecchio 1815lm
 Potenza totale assorbita 32W
 220V-240V AC 50/60Hz / DC Non Dimmerabile
 Ottica fissa

h(m)	63°	
	Ø(m)	E(lx)
1	1.23	1835
2	2.46	459
3	3.69	204
4	4.92	115
5	6.15	73

**A richiesta versione con fasci:
 7°, 10°x44°**

Fisso anello INOX

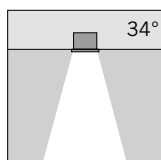
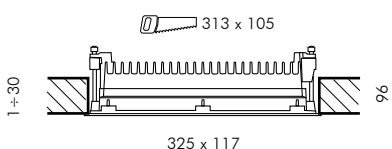
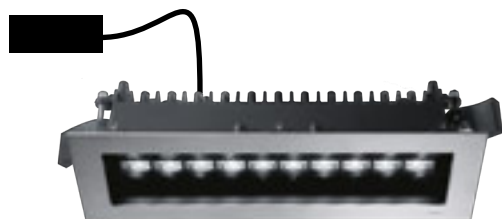

S.7475W.19 □
 20 HIGH-POWER LED **3000K** CRI90 3140lm
 Flusso luminoso apparecchio 2281lm
 Potenza totale assorbita 32W
 220V-240V AC 50/60Hz / DC Non Dimmerabile
 Ottica fissa

h(m)	34°	
	Ø(m)	E(lx)
1	0.62	6177
2	1.23	1544
3	1.85	686
4	2.46	386
5	3.08	247

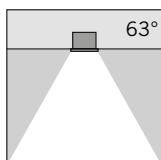

S.7476W.19 □
 20 HIGH-POWER LED **3000K** CRI90 3140lm
 Flusso luminoso apparecchio 1815lm
 Potenza totale assorbita 32W
 220V-240V AC 50/60Hz / DC Non Dimmerabile
 Ottica fissa

h(m)	63°	
	Ø(m)	E(lx)
1	1.23	1835
2	2.46	459
3	3.69	204
4	4.92	115
5	6.15	73

**A richiesta versione con fasci:
 7°, 10°x44°**

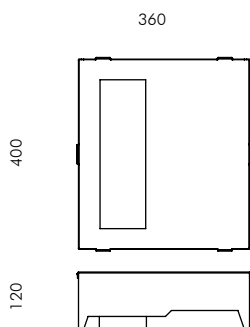

S.7479

CASSAFORMA PER SOFFITTI IN CEMENTO
 per CATCH RETTANGOLARE 20 LED FISSO
 Dim. 400 x 360 x 120mm
 Foro d'incasso 313 x 105mm