

Trim is a family of wall appliques and bollards, with rectangular and square shapes, characterized by essential lines that contemplate the "solids and voids of light". Trim is a lighting fixture suitable for classical or modern context, able to give atmosphere and charm to the surrounding environment. Created by the combination of aluminium and glass, Trim is an extremely versatile lighting solution.

TECHNICAL DESCRIPTION

Die-cast aluminium housing, extruded aluminium structure (bollard version) with high corrosion resistance. Toughened glass diffuser 4mm thick. Stainless steel A4 screws. Silicone gaskets. Double powder paint.

APPLIQUE

Luminaire supplied with 5,0m neoprene H05RN-F cable.

BOLLARD

Luminaire supplied with 4,0m neoprene H05RN-F cable.

PROTECTION CLASS
IP54

ISOLATION CLASS
CLASS III ⚡

MECHANICAL RESISTANCE
IK 06 TRIM HORIZONTAL, BOLLARDS
IK 09

COLOURS

.01 White

.14 Aluminium Grey

REGISTERED DESIGN



www.simes.it/trim

TRIM Square

SIMES

TRIM Rectangular

SIMES

Trim Square 170

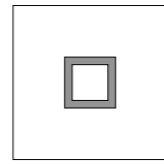
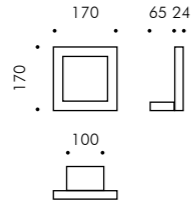

S.3152W
LED MODULE **3000K** CRI90 1056lm 7,9W
(on request 2700K CRI90 1003lm)
(on request 4000K CRI80 1315lm)
24Vdc PWM
Requires constant voltage 24Vdc remote power supply
(page 522-523).

Trim Horizontal

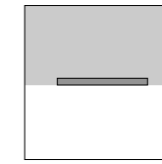
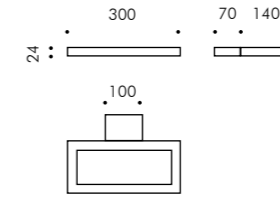

S.3175W
LED MODULE **3000K** CRI90 2112lm 15,8W
(on request 2700K CRI90 2006lm)
(on request 4000K CRI80 2630lm)
24Vdc PWM
Requires constant voltage 24Vdc remote power supply
(page 522-523).

Trim Square 170 bollard

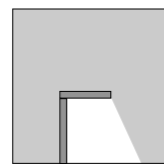
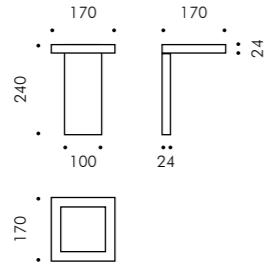

S.3153W
LED MODULE **3000K** CRI90 1056lm 7,9W
(on request 2700K CRI90 1003lm)
(on request 4000K CRI80 1315lm)
24Vdc PWM
Requires constant voltage 24Vdc remote power supply
(page 522-523).

Trim Rectangular

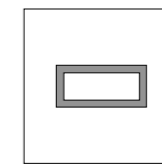
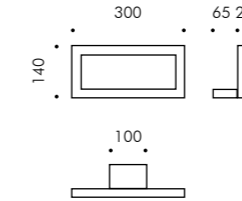

S.3176W
LED MODULE **3000K** CRI90 2112lm 15,8W
(on request 2700K CRI90 2006lm)
(on request 4000K CRI80 2630lm)
24Vdc PWM
Requires constant voltage 24Vdc remote power supply
(page 522-523).

Trim Square 240

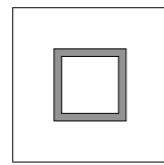
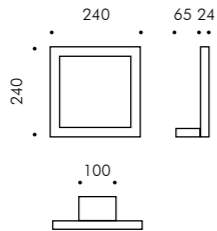

S.3157W
LED MODULE **3000K** CRI90 2112lm 15,8W
(on request 2700K CRI90 2006lm)
(on request 4000K CRI80 2630lm)
24Vdc PWM
Requires constant voltage 24Vdc remote power supply
(page 522-523).

Trim Rectangular bollard

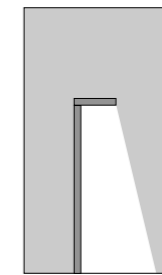
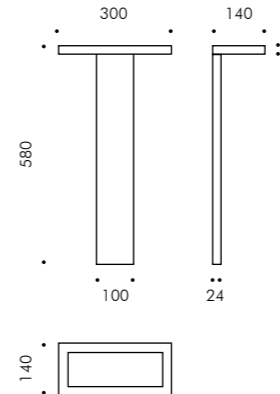

S.3177W
LED MODULE **3000K** CRI90 2112lm 15,8W
(on request 2700K CRI90 2006lm)
(on request 4000K CRI80 2630lm)
24Vdc PWM
Requires constant voltage 24Vdc remote power supply
(page 522-523).

Trim Square 240 bollard

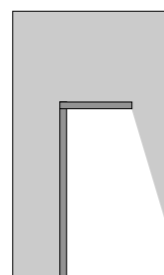
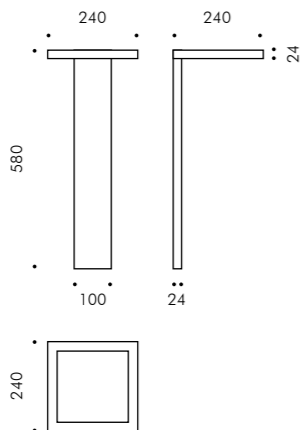

S.3158W
LED MODULE **3000K** CRI90 2112lm 15,8W
(on request 2700K CRI90 2006lm)
(on request 4000K CRI80 2630lm)
24Vdc PWM
Requires constant voltage 24Vdc remote power supply
(page 522-523).



Accessory
S.3159
FLANGE FOR TRIM BOLLARD
Flange to be anchored in concrete
for S.3153W, S.3158W and S.3177W.



Accessory
S.3159
FLANGE FOR TRIM BOLLARD
Flange to be anchored in concrete
for S.3153W, S.3158W and S.3177W.

