

Look is an elegant geometric luminaire in aluminum and glass, minimal and compact. A small overhang that can be installed on the wall or on its bollard. Look family is available as wall appliques and bollards of many different sizes. Mini Look bollard is in 24V with remote power supply, to contain as much as possible its dimensions, while all the other versions, are available with integrated power supply. Look Applique versions are offered mono or bi-emission, while Look Bollard is offered with single or double side lighting.

**TECHNICAL DESCRIPTION**

Die-cast aluminium housing, extruded aluminium structure (bollard version) with high corrosion resistance. Toughened glass diffuser. Stainless steel A4 screws. Silicone gaskets. Double powder paint.

**MINILOOK L 220mm**

Luminaire supplied with 1,0m neoprene H05RN-F cable.

**LOOK L 290mm APPLIQUE**

Luminaire with one single cable entry and grommet.

**BOLLARD**

Luminaire supplied with neoprene H05RN-F cable and connector.

**REGISTERED DESIGN**

**PROTECTION CLASS**  
IP65

**ISOLATION CLASS**

CLASS I ⊕ LOOK 290mm (Applique)  
CLASS II ⊞  
CLASS III ⊚ MICROLOOK

**MECHANICAL RESISTANCE**

IK 04 LOOK APPLIQUE 290mm  
IK 06 MINILOOK 220mm,  
LOOK BOLLARD 290mm



**COLOURS**

- .01 White
- .14 Aluminium Grey
- .20 Burnished Bronze
- .24 Anthracite Grey



[www.simes.it/look](http://www.simes.it/look)

## MINILOOK Applique 220mm

SIMES

Minilook applique 220mm

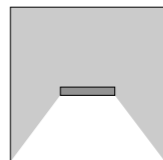

**S.7201W Single emission**  
LED MODULE **3000K** CRI90 1313lm 11,1W  
(on request 2700K CRI90 1247lm)  
(on request 4000K CRI80 1751lm)  
220V-240Vac 50/60Hz  
ON/OFF Not Dimmable

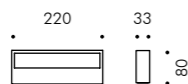

Minilook applique 220mm

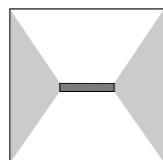
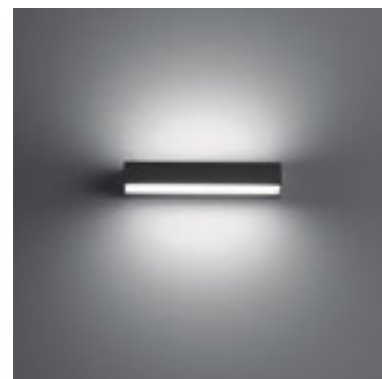

**S.7202W Double emission**  
LED MODULE **3000K** CRI90 1313lm 11,1W  
(on request 2700K CRI90 1247lm)  
(on request 4000K CRI80 1751lm)  
220V-240Vac 50/60Hz  
ON/OFF Not Dimmable

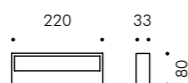

## LOOK Applique 290mm

Look applique 290mm

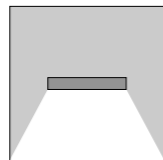

**S.7250W Single emission**  
LED MODULE **3000K** CRI90 2100lm 17,8W  
(on request 2700K CRI90 1995lm)  
(on request 4000K CRI80 2801lm)  
220V-240Vac 50/60Hz  
**Phase-cut dimmer**  
Version with DALI 2 / PUSH power supply available on request with surcharge.



Look applique 290mm

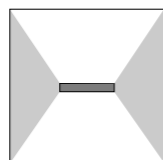

**S.7252W Double emission**  
LED MODULE **3000K** CRI90 2100lm 17,8W  
(on request 2700K CRI90 1995lm)  
(on request 4000K CRI80 2801lm)  
220V-240Vac 50/60Hz  
**Phase-cut dimmer**  
Version with DALI 2 / PUSH power supply available on request with surcharge.





## MICROLOOK Bollard 125mm

SIMES

Microlook bollard H 220mm

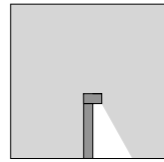
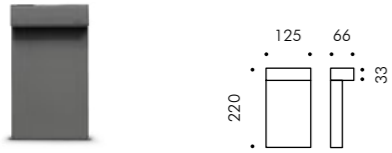

**S.7216W Single emission**  
LED MODULE **3000K** CRI90 457lm 3,3W  
(on request 2700K CRI90 434lm)  
(on request 4000K CRI80 560lm)  
**24Vdc PWM**  
Requires constant voltage 24Vdc  
remote power supply (page 522-523)

Microlook bollard H 450mm

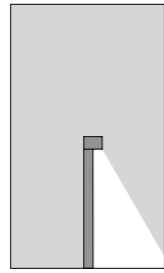
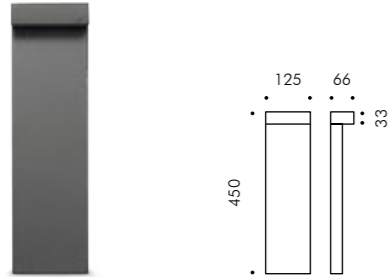

**S.7217W Single emission**  
LED MODULE **3000K** CRI90 457lm 3,3W  
(on request 2700K CRI90 434lm)  
(on request 4000K CRI80 560lm)  
**24Vdc PWM**  
Requires constant voltage 24Vdc  
remote power supply (page 522-523)

### Accessory



**S.7219**  
**FLANGE FOR MICROLOOK BOLLARD 125mm**  
Flange to be anchored in concrete  
for S.7216W and S.7217W.

## MINILOOK Bollard 220mm

Minilook bollard H 220mm

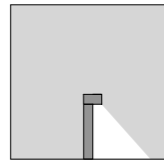
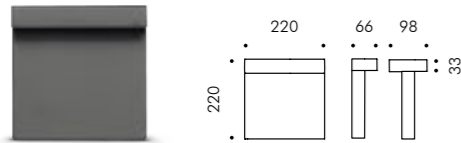

**S.7206W Single emission**  
LED MODULE **3000K** CRI90 1050lm 8,9W  
(on request 2700K CRI90 997lm)  
(on request 4000K CRI80 1400lm)  
220V-240Vac 50/60Hz  
ON/OFF Not Dimmable

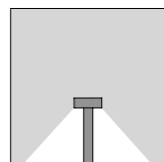

**S.7215W Double emission**  
2 x LED MODULE **3000K** CRI90 1050lm 8,9W  
(on request 2700K CRI90 997lm)  
(on request 4000K CRI80 1400lm)  
220V-240Vac 50/60Hz  
ON/OFF Not Dimmable

Minilook bollard H 580mm

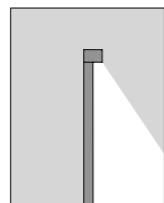
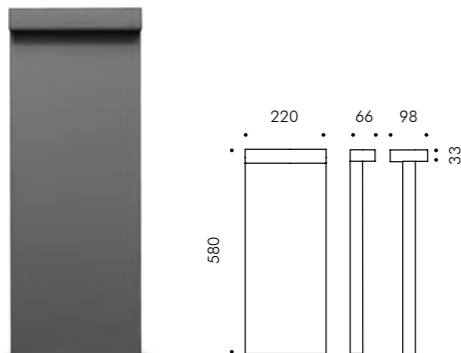

**S.7211W Single emission**  
LED MODULE **3000K** CRI90 1050lm 8,9W  
(on request 2700K CRI90 997lm)  
(on request 4000K CRI80 1400lm)  
220V-240Vac 50/60Hz  
ON/OFF Not Dimmable

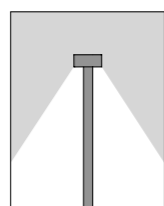

**S.7220W Double emission**  
2 x LED MODULE **3000K** CRI90 1050lm 8,9W  
(on request 2700K CRI90 997lm)  
(on request 4000K CRI80 1400lm)  
220V-240Vac 50/60Hz  
ON/OFF Not Dimmable

### Accessory



**S.7249**  
**FLANGE FOR MINILOOK BOLLARD 220mm**  
Flange to be anchored in concrete  
for S.7206W, S.7215W, S.7211W and S.7220W.



Uniquum Advocaten, Kortrijk, Belgium - Klaris architecten © Annick Verminnen



# LOOK Bollard 290mm

SIMES

Look bollard H 290mm

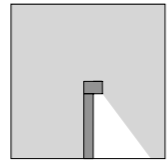
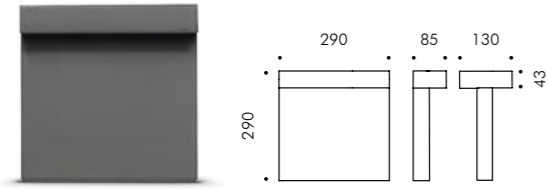

**S.7260W Single emission**  
LED MODULE 3000K  
CRI90 2100lm 17,8W  
(on request 2700K CRI90 1995lm)  
(on request 4000K CRI80 2801lm)  
220V-240Vac 50/60Hz  
**Dimmable DALI 2 / PUSH**

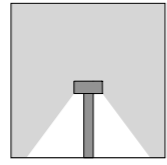

**S.7265W Double emission**  
2 x LED MODULE 3000K  
CRI90 2100lm 17,8W  
(on request 2700K CRI90 1995lm)  
(on request 4000K CRI80 2801lm)  
220V-240Vac 50/60Hz  
**Dimmable DALI 2 / PUSH**

Look bollard H 580mm

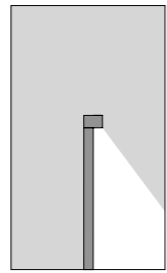
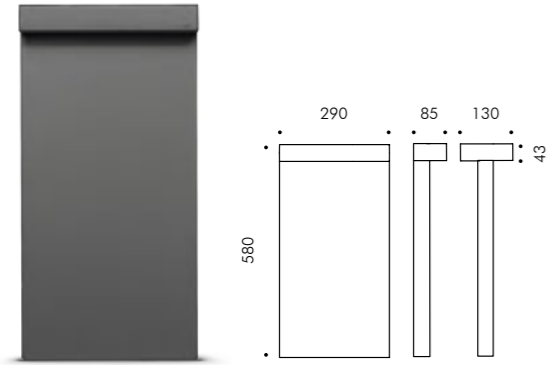

**S.7261W Single emission**  
LED MODULE 3000K  
CRI90 2100lm 17,8W  
(on request 2700K CRI90 1995lm)  
(on request 4000K CRI80 2801lm)  
220V-240Vac 50/60Hz  
**Dimmable DALI 2 / PUSH**

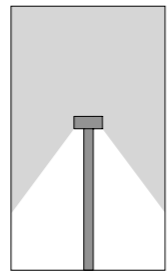

**S.7266W Double emission**  
2 x LED MODULE 3000K  
CRI90 2100lm 17,8W  
(on request 2700K CRI90 1995lm)  
(on request 4000K CRI80 2801lm)  
220V-240Vac 50/60Hz  
**Dimmable DALI 2 / PUSH**

Look bollard H 870mm

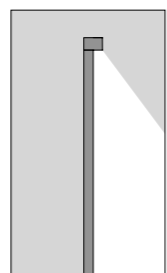
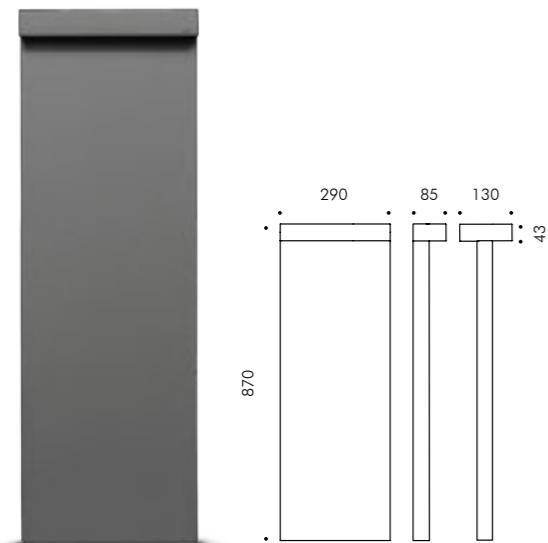

**S.7262W Single emission**  
LED MODULE 3000K  
CRI90 2100lm 17,8W  
(on request 2700K CRI90 1995lm)  
(on request 4000K CRI80 2801lm)  
220V-240Vac 50/60Hz  
**Dimmable DALI 2 / PUSH**

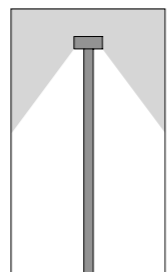

**S.7267W Double emission**  
2 x LED MODULE 3000K  
CRI90 2100lm 17,8W  
(on request 2700K CRI90 1995lm)  
(on request 4000K CRI80 2801lm)  
220V-240Vac 50/60Hz  
**Dimmable DALI 2 / PUSH**



**Accessory**  
**S.7269**  
**FLANGE FOR LOOK BOLLARD 290mm**  
Flange to be anchored in concrete  
for S.7260W, S.7265W, S.7261W,  
S.7266W, S.7262W and S.7267W.



Filmar Headquarter, Zocco di Erbusco, Brescia, Italy - Arch. Giuliano Venturilli © Ph. Mario Bertani