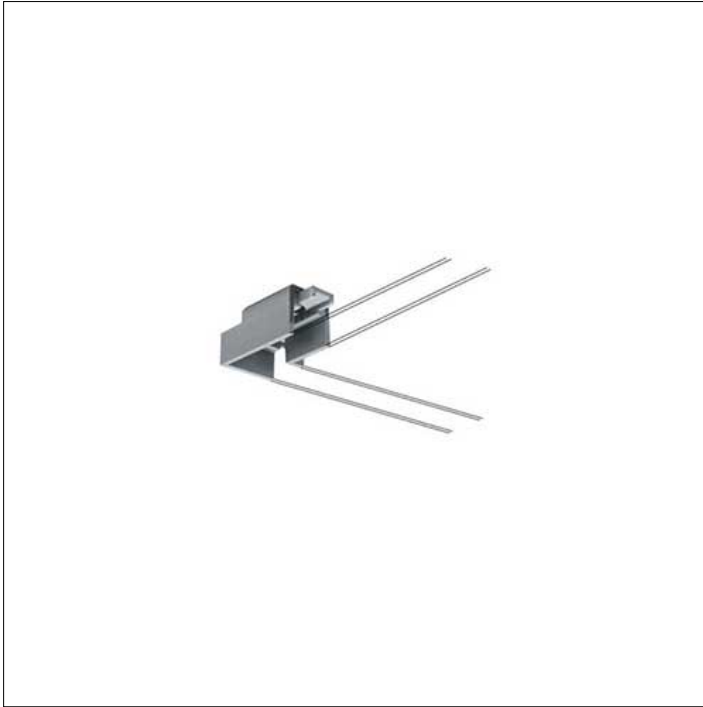

**ACCESSORY****S.2307  
90° JUNCTION ACCESSORY FOR SINGLE FLAT  
SURFACES**

All surface mounted versions may be connected to create luminous angles at 90° in relation to a single installation plan (wall or ceiling) with the specific accessories.

Accessory available in the following colors: White (cod.01), Aluminium grey (cod.14)