

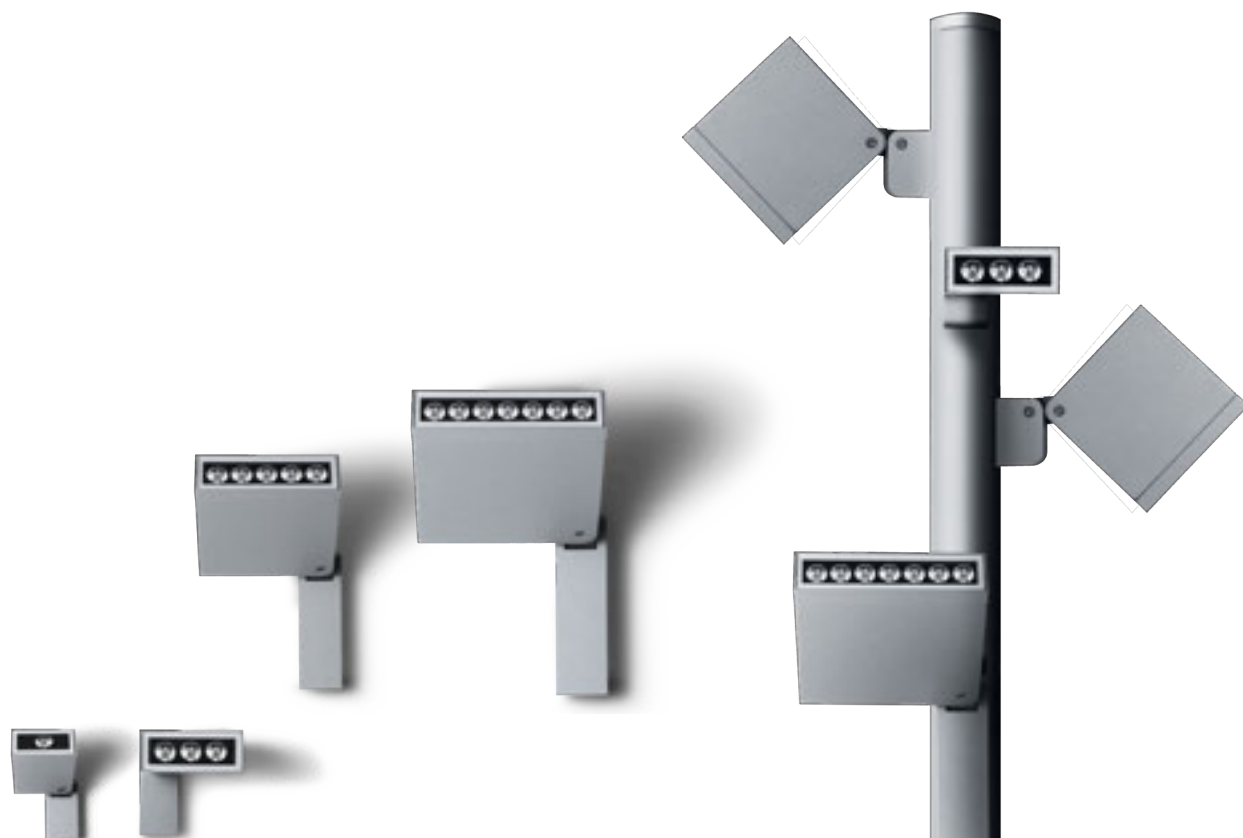

Gubbio Cathedral, Perugia, Italy - Arch. Francesco Raschi (Lighting design)



Keen

Adjustable spot projector

Keen represents the evolution of outdoor lighting projectors. A special double joint allows the projector to take infinite positions for different light effects. Its minimal design makes it suitable for a wide range of architectural project applications. Available in four sizes, Keen is engineered with the most advanced LED technology and different optical solutions, ensuring a performing light effect and energy saving characteristics.



reddot award 2015
winner

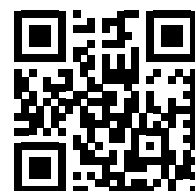

www.simes.it/keen



MICROKEEN Adjustable spot projector “Blade of light”

Die-cast EN AB-47100 aluminium housing with high corrosion resistance. Stainless steel screws. Clear toughened glass diffuser. Double joint allowing rotation on three different axis. Luminaire supplied with 1,5m of cable. Silicone gaskets.
Double powder paint.

Protection class
IP65

Isolation class
CLASS II 

Mechanical resistance
IK 07

Leds 4000K CRI90 versions are available on request.

Colours:

- White (code 01)
- Aluminium grey (code 14)

For the latest technical information and luminaire updates with LED technology please refer to www.simes.it

**PATENTED
REGISTERED DESIGN**

Axis of rotation 1

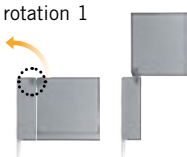

Axis of rotation 2

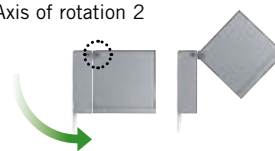

Axis of rotation 3



The special double joint guarantees total freedom in directing the light beam: the luminaire is able to rotate on three different axes.

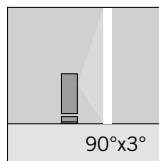

S.1506W

1 HIGH-POWER LED **3000K** CRI80 295lm
 Rated luminaire luminous flux 255lm
 Rated input power 5,2W
 220V-240V AC 50/60Hz / DC Not Dimmable
 Computer-simulated photometrics
 With Radial Lens 6°x90°

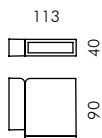

S.1508

**ACCESSORY FOR VERTICAL
 INSTALLATION of MICROKEEN**



S.1014

**STAKE for MICROKEEN,
 MINIKEEN and KEEN**
 Accessory for vertical
 installation only

Adhesive gobo for Microkeen

(included in the "Blade optic" version S.1506W)



The adhesive gobo for Microkeen can be adapted to modify the aperture of the beam and then applied on the front glass of the fixture. By simply cutting at the level of the required degrees you create a slit to allow the desired light emission.

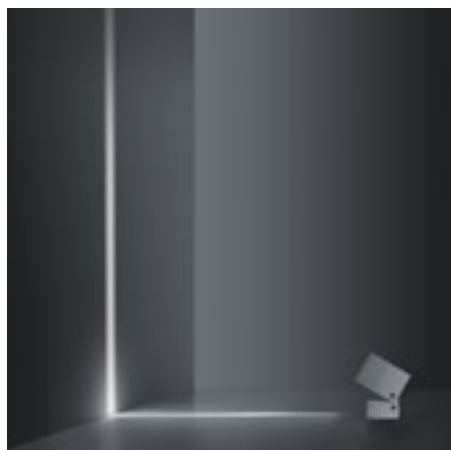

Adhesive gobo with 70° aperture

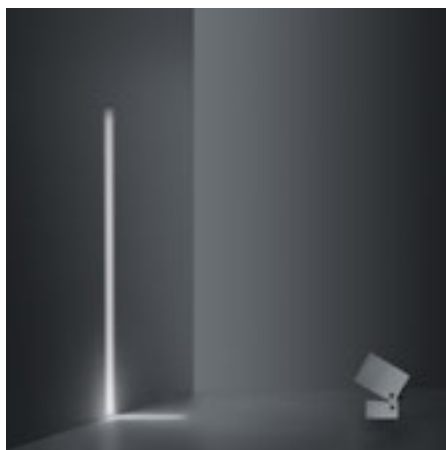

Adhesive gobo with 50° aperture



Adhesive gobo with 30° aperture

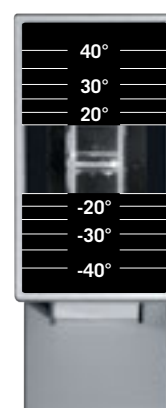

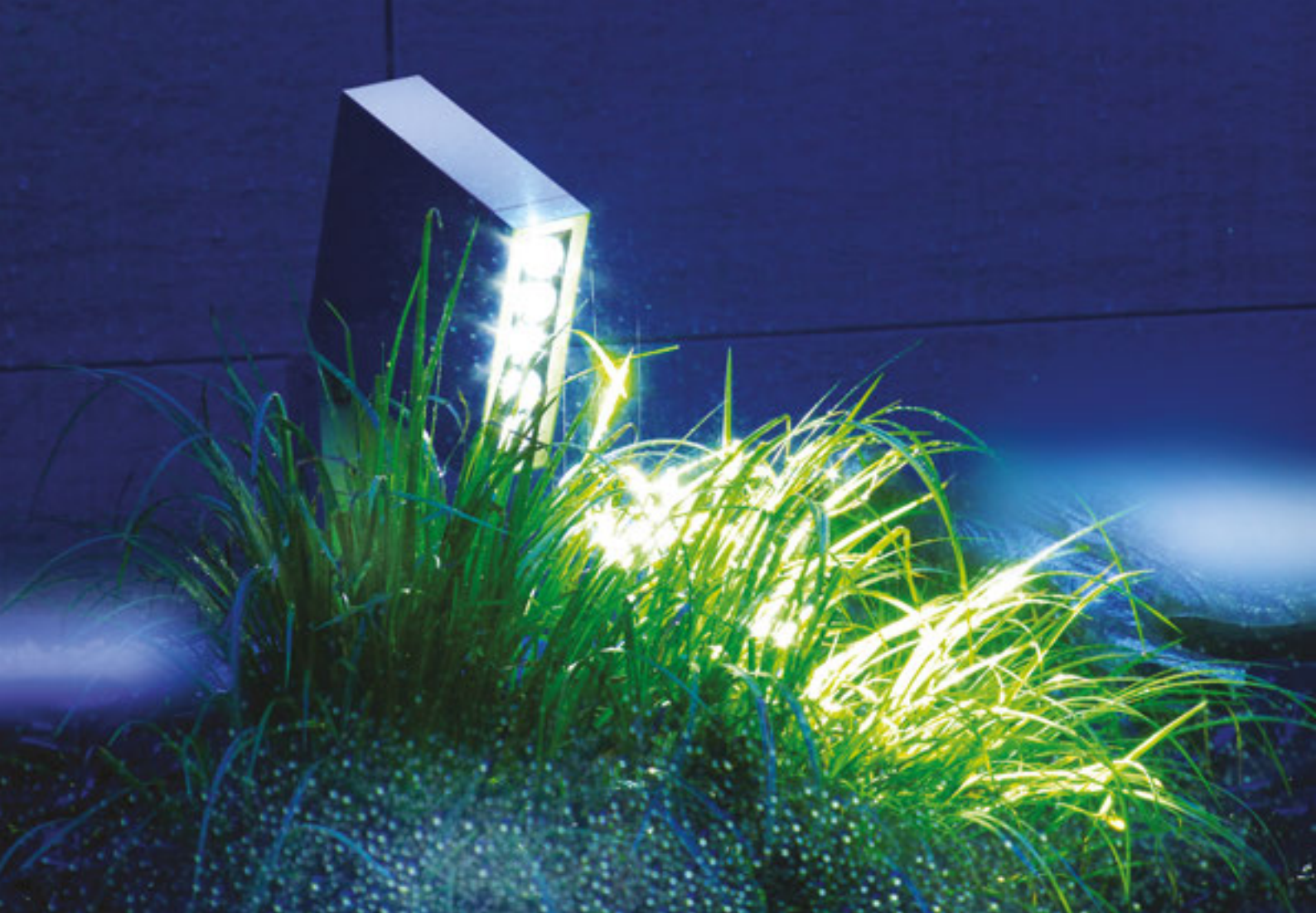

KEEN Adjustable spot projector

Die-cast EN AB-47100 aluminium housing with high corrosion resistance. Stainless steel screws.
Clear toughened glass diffuser.
Double joint allowing rotation on three different axis.
Luminaire supplied with 1,5m of cable (Microkeen and Minikeen).
Pre-wired luminaire with neoprene cable (Keen and Megakeen).
Silicone gaskets.
Double powder paint.

Protection class
IP65

Isolation class
CLASS II

Mechanical resistance
IK 07 MICRO/MINIKEEN
IK 06 KEEN/MEGAKEEN



Leds 4000K CRI90 versions are available on request.

Colours:

- White (code 01)
- Aluminium grey (code 14)

For the latest technical information and luminaire updates with LED technology please refer to www.simes.it

**PATENTED
REGISTERED DESIGN**

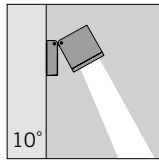

S.1505W

1 HIGH-POWER LED **3000K** CRI90 295lm
 Rated luminaire luminous flux 255lm
 Rated input power 5,1W
 220V-240V AC 50/60Hz / DC Not Dimmable

h(m)	10° Ø(m)	3000K E(lx)
2	0.36	1368
4	0.71	342
6	1.07	152
8	1.43	85
10	1.78	55

**Beam lenses available on request with no surcharge:
 24°, 42° and 12°x40°**

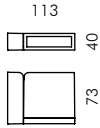

S.1508

**ACCESSORY FOR VERTICAL
 INSTALLATION of MICROKEEN**



S.1014

**STAKE for MICROKEEN,
 MINIKEEN and KEEN**
 Accessory for vertical
 installation only

MINIKEEN

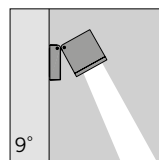

S.1500W

3 HIGH-POWER LEDs **3000K** CRI90 710lm
 Rated luminaire luminous flux 510lm
 Rated input power 7,6W
 220V-240V AC 50/60Hz / DC Not Dimmable

h(m)	9° Ø(m)	3000K E(lx)
2	0.32	2824
4	0.64	706
6	0.97	314
8	1.29	176
10	1.61	113

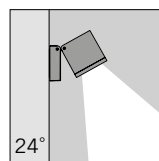

S.1501W

3 HIGH-POWER LEDs **3000K** CRI90 710lm
 Rated luminaire luminous flux 511lm
 Rated input power 7,6W
 220V-240V AC 50/60Hz / DC Not Dimmable

h(m)	24° Ø(m)	3000K E(lx)
2	0.84	650
4	1.69	162
6	2.53	72
8	3.37	41
10	4.21	26

**Beam lenses available on request with no surcharge:
 42° and 12°x40°**

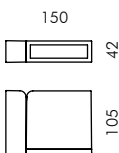

S.1509

**ACCESSORY FOR VERTICAL
 INSTALLATION of MINIKEEN**



S.1014

**STAKE for MICROKEEN,
 MINIKEEN and KEEN**
 Accessory for vertical
 installation only

KEEN

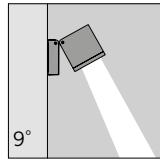

S.1510W

5 HIGH-POWER LEDs **3000K** CRI90 1180lm
 Rated luminaire luminous flux 965lm
 Rated input power 16W
 220V-240V AC 50/60Hz / DC Not Dimmable

h(m)	9° Ø(m)	3000K E(lx)
2	0.31	5148
4	0.63	1287
6	0.94	572
8	1.26	322
10	1.57	206

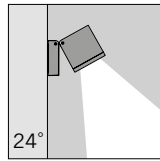

S.1511W

5 HIGH-POWER LEDs **3000K** CRI90 1180lm
 Rated luminaire luminous flux 909lm
 Rated input power 16W
 220V-240V AC 50/60Hz / DC Not Dimmable

h(m)	24° Ø(m)	3000K E(lx)
2	0.86	1127
4	1.72	282
6	2.57	125
8	3.43	70
10	4.29	45

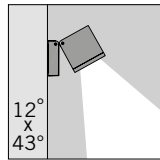

S.1513W

5 HIGH-POWER LEDs **3000K** CRI90 1180lm
 Rated luminaire luminous flux 886lm
 Rated input power 16W
 220V-240V AC 50/60Hz / DC Not Dimmable
 With ellipsoidal lenses

h(m)	12°x43° Ø(m)	3000K E(lx)
2	0.41 x 1.59	1039
4	0.81 x 3.18	260
6	1.22 x 4.78	115
8	1.63 x 6.37	65
10	2.03 x 7.96	42

**Beam lenses available on request with no surcharge:
 42°**



S.1519

**ACCESSORY FOR VERTICAL
 INSTALLATION of KEEN**



S.1014

**STAKE for MICROKEEN,
 MINIKEEN and KEEN**
 Accessory for vertical installation
 only

MEGAKEEN

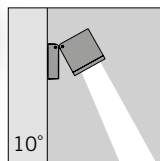
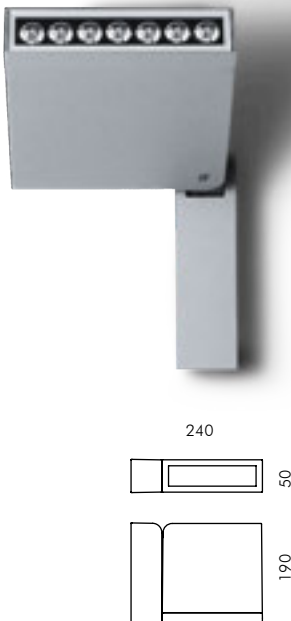

S.1515W

7 HIGH-POWER LEDs **3000K** CRI90 2100lm
 Rated luminaire luminous flux 1640lm
 Rated input power 26,5W
 220V-240V AC 50/60Hz / DC Not Dimmable

h(m)	10° Ø(m)	3000K E(lx)
2	0.34	8664
4	0.69	2166
6	1.03	963
8	1.37	541
10	1.71	347

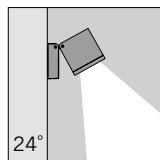

S.1516W

7 HIGH-POWER LEDs **3000K** CRI90 2100lm
 Rated luminaire luminous flux 1642lm
 Rated input power 26,5W
 220V-240V AC 50/60Hz / DC Not Dimmable

h(m)	24° Ø(m)	3000K E(lx)
2	0.86	1867
4	1.72	467
6	2.57	207
8	3.43	117
10	4.29	75

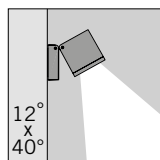

S.1517W

7 HIGH-POWER LEDs **3000K** CRI90 2100lm
 Rated luminaire luminous flux 1527lm
 Rated input power 26,5W
 220V-240V AC 50/60Hz / DC Not Dimmable
 With ellipsoidal lenses

h(m)	12°x40° Ø(m)	3000K E(lx)
2	0.41 x 1.42	2086
4	0.83 x 2.83	521
6	1.24 x 4.25	232
8	1.65 x 5.67	130
10	2.07 x 7.08	83

**Beam lenses available on request with no surcharge:
 42°**

Megakeen projector in standard version can be fixed also to poles.



S.3049

STAKE for MEGAKEEN

The Keen, Minikeen and Microkeen pole versions have extended the project application configurations of this new projector. Thanks to the special anchor base the luminaire can be fixed to new or existing poles of diameter of no less than 60mm. Pre-wired luminaire with 6m of neoprene cable.



Microkeen "Blade of light" pole mounted

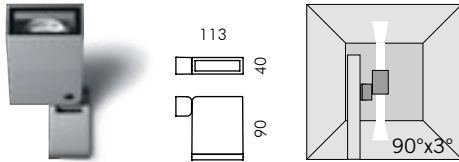

S.1546W

1 HIGH-POWER LED **3000K** CRI80 295lm
 Rated luminaire luminous flux 255lm
 Rated input power 5,2W
 220V-240V AC 50/60Hz / DC Not Dimmable
 Computer-simulated photometrics
 With Radial Lens 6°x90°

Microkeen pole mounted

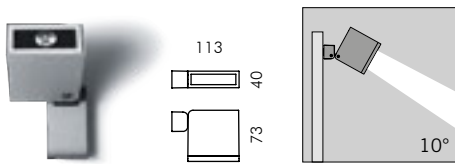

S.1545W

1 HIGH-POWER LED **3000K** CRI90 295lm
 Rated luminaire luminous flux 255lm
 Rated input power 5,1W
 220V-240V AC 50/60Hz / DC Not Dimmable

**Beam lenses available on request with no surcharge:
 24°, 42° and 12°x40°**

Minikeen pole mounted

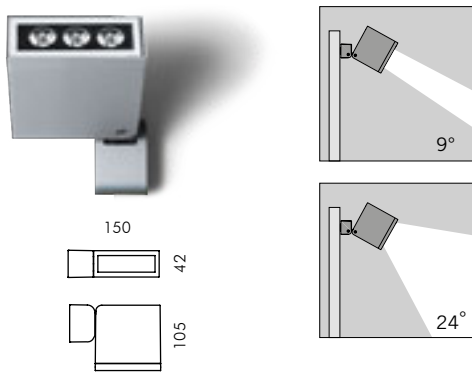

S.1520W

3 HIGH-POWER LEDs **3000K** CRI90 710lm
 Rated luminaire luminous flux 510lm
 Rated input power 7,6W
 220V-240V AC 50/60Hz / DC Not Dimmable

S.1521W

3 HIGH-POWER LEDs **3000K** CRI90 710lm
 Rated luminaire luminous flux 511lm
 Rated input power 7,6W
 220V-240V AC 50/60Hz / DC Not Dimmable

**Beam lenses available on request
 with no surcharge:
 42° and 12°x40°**

Keen pole mounted

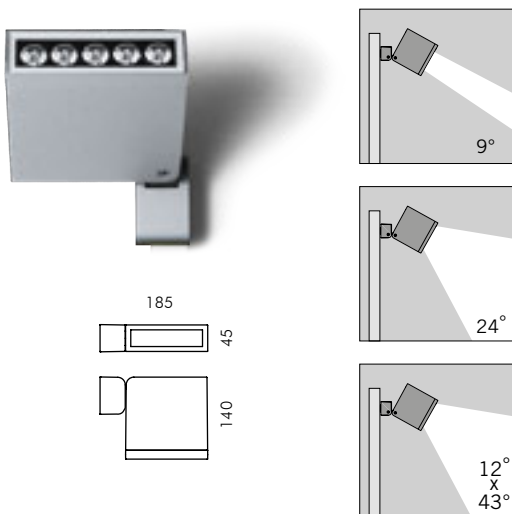

S.1530W

5 HIGH-POWER LEDs **3000K** CRI90 1180lm
 Rated luminaire luminous flux 965lm
 Rated input power 16W
 220V-240V AC 50/60Hz / DC Not Dimmable

S.1531W

5 HIGH-POWER LEDs **3000K** CRI90 1180lm
 Rated luminaire luminous flux 909lm
 Rated input power 16W
 220V-240V AC 50/60Hz / DC Not Dimmable

S.1533W

5 HIGH-POWER LEDs **3000K** CRI90 1180lm
 Rated luminaire luminous flux 886lm
 Rated input power 16W
 220V-240V AC 50/60Hz / DC Not Dimmable
 With ellipsoidal lenses

**Beam lenses available on request with no surcharge:
 42°**